

# SEAX

Design by JEAN-MARIE MASSAUD

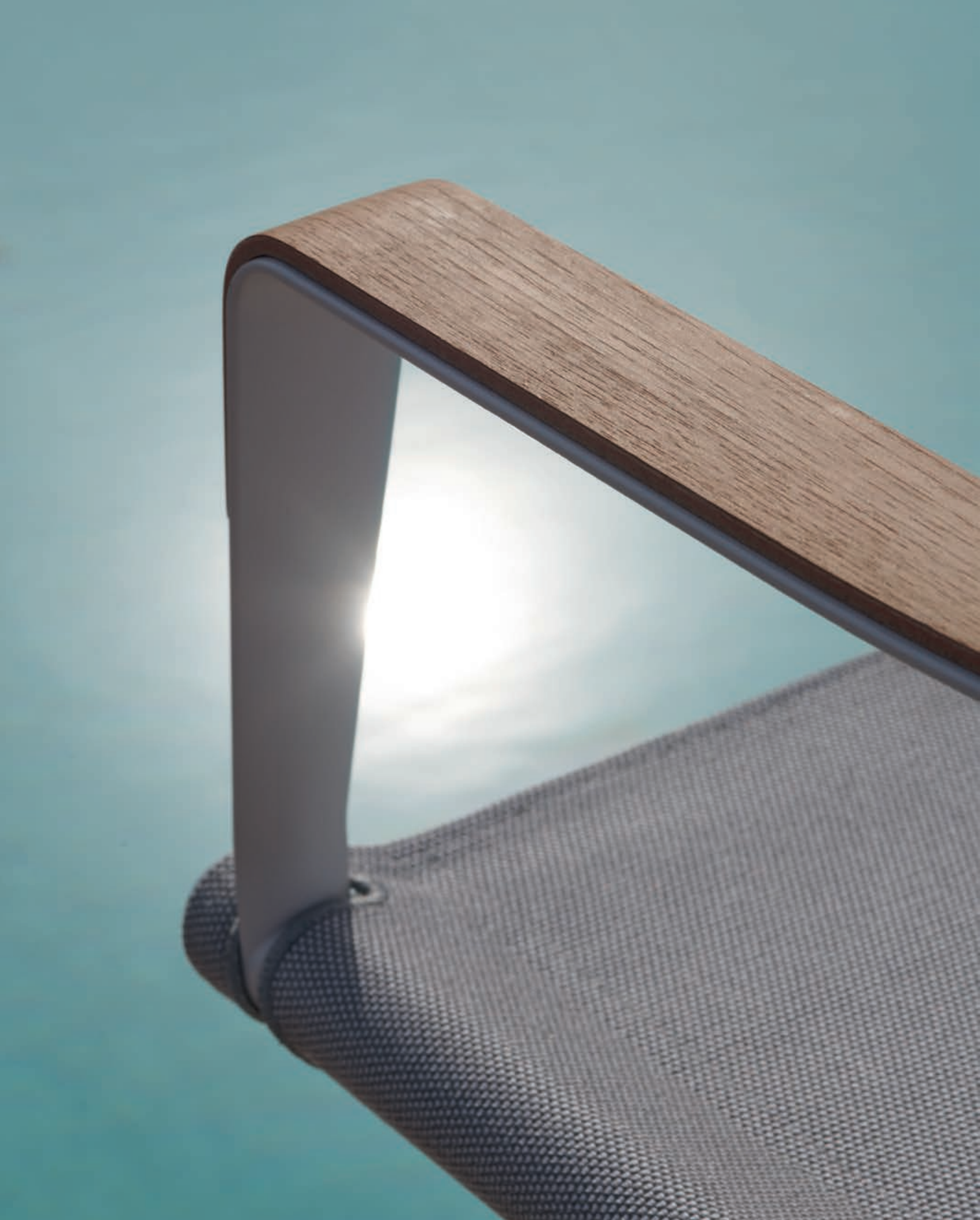

Armchairs lipari, sail taupe

# SEAX

Design by JEAN-MARIE MASSAUD

## Typology

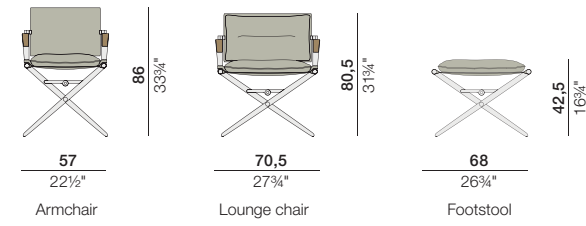

## Materials

### Combinations

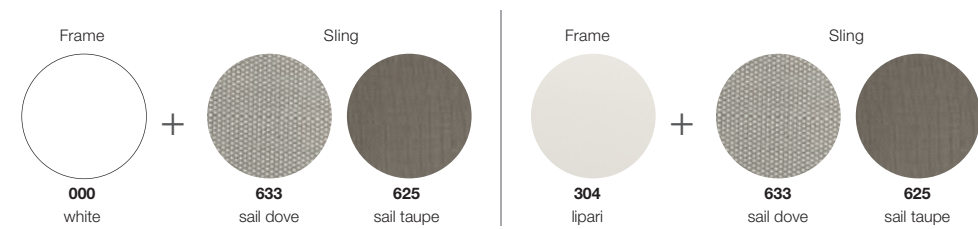
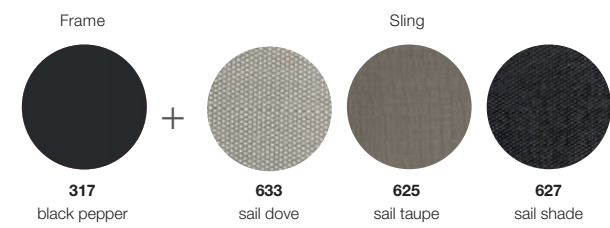

### Armrests



## Fabric Information (see page 224)

Cushions for this collection are available in all fabrics Cat. A, B & Cat. C (only Kvadrat® Atrium).  
Kissen für diese Kollektion sind in den Stoffen der Kat. A, B & Kat. C (nur Kvadrat® Atrium) verfügbar.

RRP/UVF

ARMCHAIR  
Armlehnstuhl

7 kg  
15 lbs

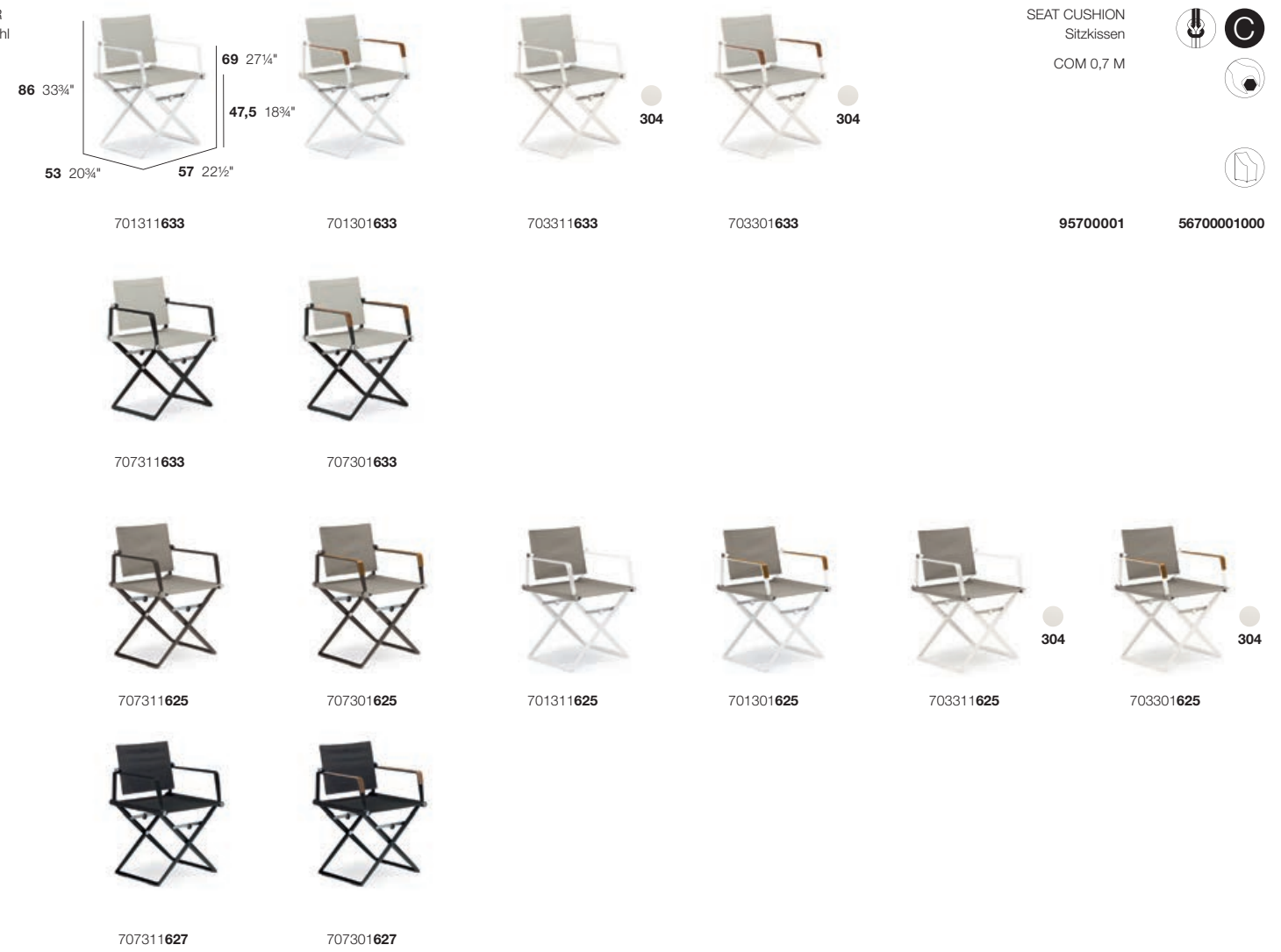

SEAT CUSHION  
Sitzkissen  
COM 0,7 M

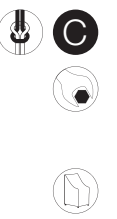

RRP/UVF

LOUNGE CHAIR  
Sessel

8 kg  
18 lbs

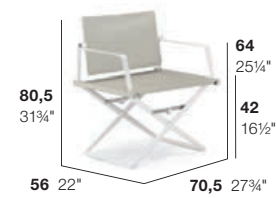

SEAT CUSHION + BACK CUSHION  
Sitzkissen + Rückenkissen  
COM 1,26 M

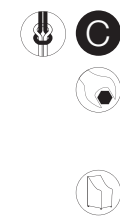

701315633

701305633

703315633

703305633

95700005

56700005000



707315633

707305633



707315625

707305625

701315625

701305625

703315625

703305625



707315627

707305627

RRP/UVF

FOOTSTOOL  
Hocker

5 kg  
11 lbs

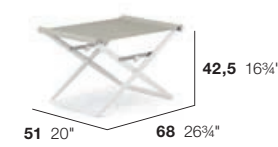

SEAT CUSHION  
Sitzkissen  
COM 0,8 M



701031633

703031633

95700031

56700031000



707031633



707031625



701031625



703031625



707031627

ALL ITEMS ARE FOLDABLE.  
Alle Produkte sind faltbar.



SEAT CUSHION ARMCHAIR  
Sitzkissen Armlehnstuhl

COM 0,7 M



SEAT CUSHION + BACK CUSHION LOUNGE CHAIR  
Sitzkissen + Rückenkissen Sessel

COM 1,26 M

SEAT CUSHION FOOTSTOOL  
Sitzkissen Hocker

COM 0,8 M



EN MATERIAL

The structure of the SEAX armchair and lounge chair is made of powder coated die-cast aluminum. The seat and back textile is a mix of PVC, acrylic and polyester. The armrest covers are made out of teak-finished plywood. Clean the frame, seat and backrest with a soft cloth and warm water. Clean the plywood armrest covers with a damp cloth and do not apply cleaning detergents of any kind. To maintain their beautiful wood finish, the SEAX armchairs and lounge chairs with plywood armrests should be protected from moisture and kept indoors when not in use. For a low-maintenance seating alternative, choose the armchair and lounge chair without plywood armrests.

DE MATERIAL

Die Rahmen von SEAX Armlehnstuhl und Sessel bestehen aus pulverbeschichtetem, druckgegossenem Aluminium. Sitzfläche und Rückenlehne bestehen aus einem Stoff, der aus PVC, Acryl und Polyester gefertigt wird. Das Holzdekor der Armlehnen besteht aus mit Teakholz beschichtetem Schichtholz. Rahmen, Sitz und Lehne mit einem weichen Tuch und warmem Wasser reinigen. Die Schichtholz-Armlehnen reinigen Sie mit einem feuchten Tuch und niemals mit Reinigungsmitteln. Schützen Sie die SEAX Armlehnstühle und Sessel vor Feuchtigkeit und bewahren Sie sie im Innenbereich auf, wenn Sie sie nicht nutzen, damit die schöne Holzoberfläche nicht leidet. Als pflegeleichte Alternative wählen Sie den Armlehnstuhl oder den Sessel mit Armlehnen ohne Holzoberflächen.



# SEAX

Design by JEAN-MARIE MASSAUD

## Typology

cm inch

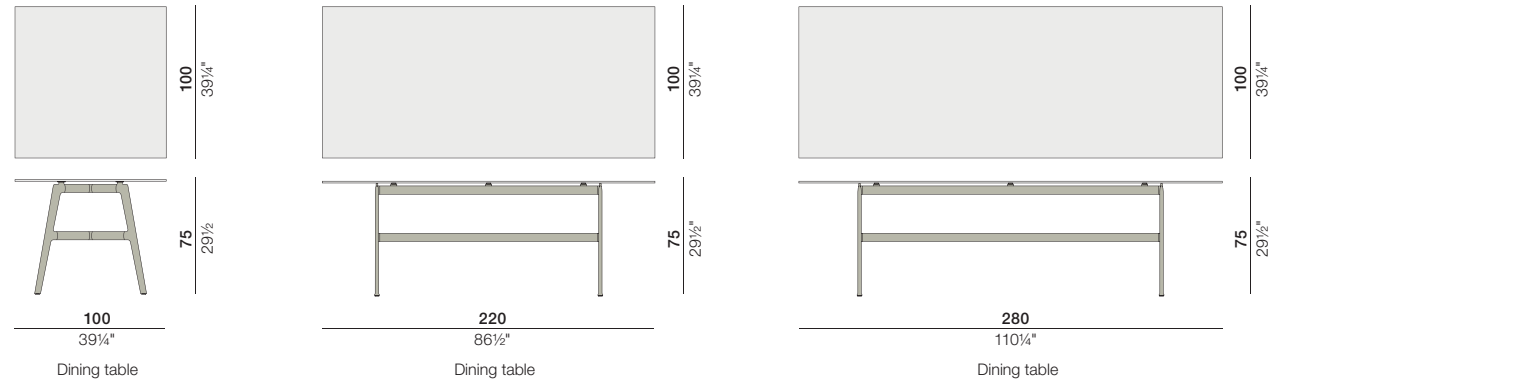
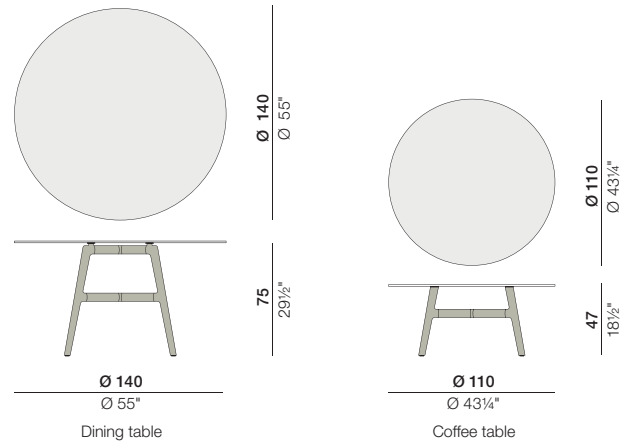

## Materials

### Base



### Tabletops

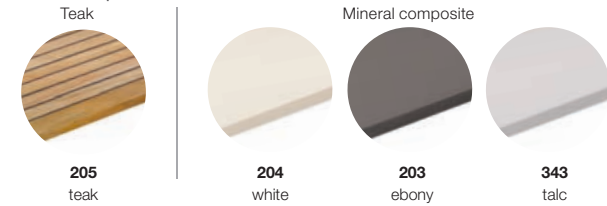

### RRP/UDP

#### DINING TABLE Esstisch

*Teak*  
100 × 100 cm  
39¼" × 39¼"  
30 kg  
67 lbs

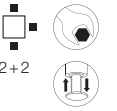
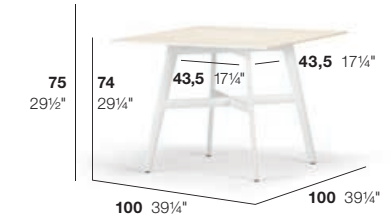

*Mineral Composite*  
100 × 100 cm  
39¼" × 39¼"  
40,5 kg  
90 lbs

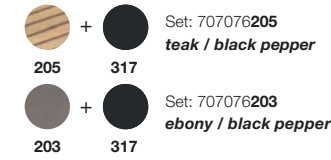
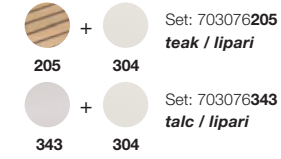

56700076000

#### DINING TABLE Esstisch

*Teak*  
100 × 220 cm  
39¼" × 86½"  
52 kg  
115 lbs

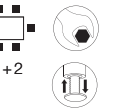
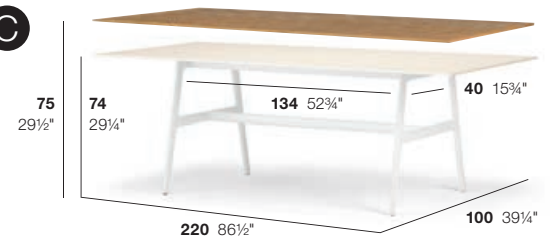

*Mineral Composite*  
100 × 220 cm  
39¼" × 86½"  
82 kg  
181 lbs

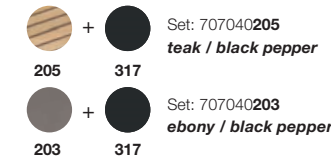
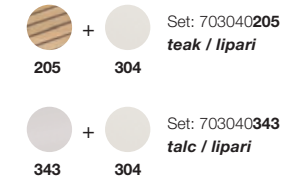

56700040000

DINING TABLE  
Esstisch

Teak  
100 × 280 cm  
39¼" × 110¼"  
63 kg  
139 lbs

205 + 000 Set: 701067205  
**teak / white**

204 + 000 Set: 701067204  
**white / white**

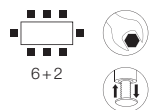
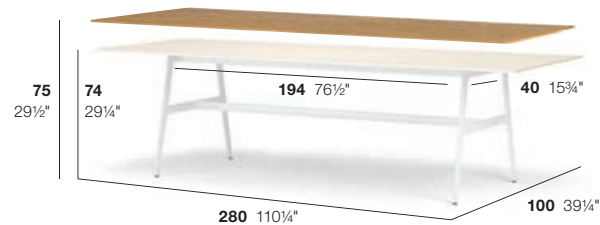

Mineral Composite  
100 × 280 cm  
39¼" × 110¼"  
99 kg  
219 lbs

205 + 304 Set: 703067205  
**teak / lipari**

343 + 304 Set: 703067343  
**talc / lipari**



205 + 317 Set: 707067205  
**teak / black pepper**

203 + 317 Set: 707067203  
**ebony / black pepper**



56700067000

DINING TABLE  
Esstisch

Teak  
Ø 140 cm  
Ø 55"  
39 kg  
86 lbs

205 + 000 Set: 701046205  
**teak / white**

204 + 000 Set: 701046204  
**white / white**

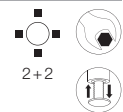
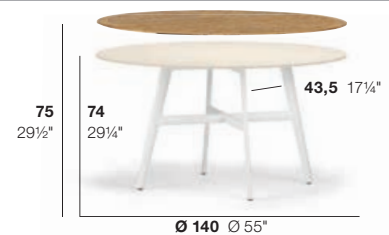

Mineral Composite  
Ø 140 cm  
Ø 55"  
56,5 kg  
125 lbs

205 + 304 Set: 703046205  
**teak / lipari**

343 + 304 Set: 703046343  
**talc / lipari**



205 + 317 Set: 707046205  
**teak / black pepper**

203 + 317 Set: 707046203  
**ebony / black pepper**



56700046000

COFFEE TABLE  
Kaffeetisch

Teak  
Ø 110 cm  
Ø 43¼"  
23 kg  
51 lbs

205 + 000 Set: 701036205  
**teak / white**

204 + 000 Set: 701036204  
**white / white**

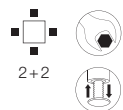
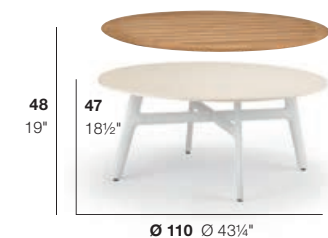

Mineral Composite  
Ø 110 cm  
Ø 43¼"  
40 kg  
89 lbs

205 + 317 Set: 707036205  
**teak / black pepper**

203 + 317 Set: 707036203  
**ebony / black pepper**



56700036000

EN MATERIAL

The base consists of powder coated aluminum profiles with powder coated, die-cast aluminum legs. Mineral composite tabletops come in three options: White, ebony and talc tabletops consist of a self-supporting mineral-composite slab, cut by water jet from the largest premium sintered porcelain slabs available on the market. Teak tabletops consist of premium teak. The sealant used between the teak slats are the same as those widely used on yacht decks and are designed to expand and contract with teak's natural movement. Wash using DEDON teak cleaner. To retain the golden-brown color of unweathered teak, we recommend applying DEDON teak oil at least once in every six months.

DE MATERIAL

Das Gestell besteht aus pulverbeschichteten Aluminiumprofilen mit pulverbeschichteten Aludruckgussbeinen. Die Tischplatten aus freitragendem Mineralverbundmaterial sind in drei Farbvarianten verfügbar: white, ebony und talc. Das Material wird per Wasserstrahl aus den größten am Markt erhältlichen gesinterten Porzellanplatten geschnitten. Einfach mit einem weichen Tuch und warmem Wasser zu reinigen. Die Teak-Tischplatte besteht aus hochwertigem Teakholz. Dichtungsfugen zwischen den Teakleisten erlauben dem Holz, sich im Rahmen seiner natürlichen Bewegung auszudehnen bzw. zusammenzuziehen. Reinigen Sie das Teakholz mit DEDON Teak Reiniger. Um den ursprünglichen goldbraunen Farbton zu bewahren, tragen Sie mindestens alle sechs Monate das DEDON Teak Öl auf.

# SEAX DINING

Design by JEAN-MARIE MASSAUD



SEAX Setting 01

- 8x 00707301625 SEAX Armchair, black pepper/sail taupe
- 1x 00707067205 SEAX Dining table 100 x 280 cm, black pepper/teak



SEAX Setting 02

- 4x 00701301633 SEAX Armchair, white/sail dove
- 1x 00701046204 SEAX Dining table Ø 140 cm, white/white
- 1x 00098025125 VID Carpet solid 300 x 400 cm, canvas
- 1x 00093140000 THE OTHERS Statue TOBO, cloud
- 1x 00093020128 THE OTHERS Lantern M, cloud



SEAX Setting 03

- 4x 00707311633 SEAX Armchair, black pepper/sail dove
- 1x 00707040203 SEAX Dining table 100 x 220 cm, black pepper/ebony



SEAX Setting 04

- 6x 00703301633 SEAX Armchair, lipari/sail dove
- 1x 00603062205 WA Dining table 100 x 200 cm, lipari/teak