

SOMBRERO

CANOPY

258

The SOMBRERO canopy is versatile and highly customizable.

Various roof and wall options create privacy and shade.

Made with a sturdy aluminum frame, these canopies are suitable for hospitality and residential.

In case of heavy winds or storms and snow, close or remove curtains to avoid damage.









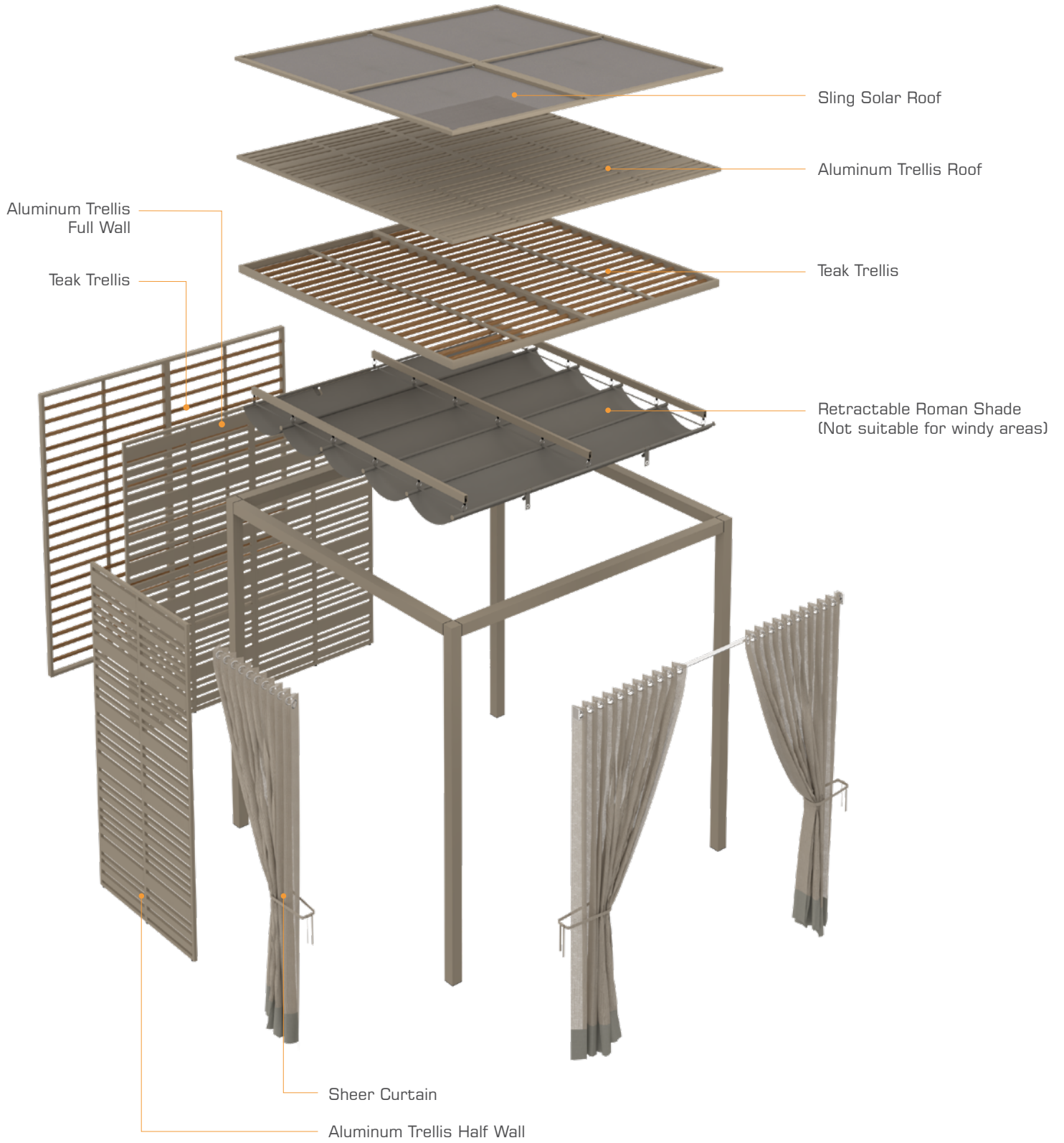



SOMBRERO CANOPY
8 ft x 8 ft / 2.4 x 2.4 m

L 8 ft | 2.4 m
W 8 ft | 2.4 m
H 8 ft | 2.4 m

		Roof			
		Sling Solar Roof	Aluminum Trellis Roof	Teak Trellis Roof	Retractable Roman Shade
Walls	Open	MG8421	MG8420	MG8797	MG8614
	Back Aluminum Trellis	MG8423	MG8422	MG8437	MG8615
	Back Teak Trellis	MG8417	MG8795	MG8798	MG8616
	Back Aluminum Trellis + 2 Side Curtains	MG8427	MG8426	MG8799	MG8617
	Back Teak Trellis + 2 Side Curtains	MG8419	MG8796	MG8440	MG8618
	Back Aluminum Trellis + 2 Side Curtains + Front Curtain	MG8456	MG8458	MG8480	MG8619
	Back Teak Trellis + 2 Side Curtains + Front Curtain	MG8457	MG8459	MG8469	MG8620
	Curtains on 4 sides	MG8429	MG8428	MG8439	MG8623

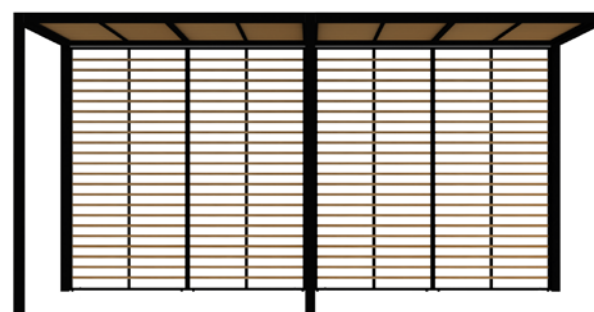

SOMBRERO CANOPY
8 ft x 16 ft / 2.4 x 4.8 m

L 8 ft | 2.4 m
W 16 ft | 4.8 m
H 8 ft | 2.4 m

		Roof			
		Sling Solar Roof	Aluminum Trellis Roof	Teak Trellis Roof	Retractable Roman Shade
Walls	Open	MG8431	MG8631	MG8640	MG8649
	Back Aluminum Trellis (full)	MG8433	MG8805	MG8641	MG8650
	Back + 1 Wall Aluminum Trellis (indicate position)	MG8801	MG8806	MG8642	MG8651
	Back + 2 Walls Aluminum Trellis	MG8802	MG8807	MG8643	MG8652
	Back Teak Trellis (full)	MG8803	MG8635	MG8644	MG8653
	Back + 1 Wall Teak Trellis (indicate position)	MG8627	MG8636	MG8645	MG8654
	Back + 2 Walls Teak Trellis	MG8628	MG8637	MG8646	MG8655
	Back Aluminum Trellis + 2 Side curtains + Front Curtain	MG8438	MG8638	MG8647	MG8656
	Back Teak Trellis + 2 Side curtains + Front Curtain	MG8804	MG8639	MG8648	MG8657



SOMBRERO CANOPY
8 ft x 24 ft / 2.4 x 7.3 m

L 8 ft | 2.4 m
W 24 ft | 7.3 m
H 8 ft | 2.4 m

		Roof			
		Sling Solar Roof	Aluminum Trellis Roof	Teak Trellis Roof	Retractable Roman Shade
Walls	Open	MG8470	MG8662	MG8673	MG8684
	Back Aluminum Trellis (full)	MG8472	MG8663	MG8674	MG8685
	Back + 1 Wall Aluminum Trellis (indicate position)	MG8474	MG8664	MG8675	MG8686
	Back + 2 Walls Aluminum Trellis	MG8658	MG8665	MG8676	MG8687
	2/3 Back Aluminum Trellis (indicate position)	MG8471	MG8666	MG8677	MG8688
	2/3 Back + 1 Wall Aluminum Trellis (indicate position)	MG8659	MG8667	MG8678	MG8689
	Back Teak Trellis (full)	MG8808	MG8668	MG8679	MG8690
	Back + 1 Wall Teak Trellis (indicate position)	MG8809	MG8669	MG8680	MG8691
	Back + 2 Walls Teak Trellis	MG8660	MG8670	MG8681	MG8692
	2/3 Back Teak Trellis (indicate position)	MG8810	MG8671	MG8682	MG8693
	2/3 Back + 1 Wall Teak Trellis (indicate position)	MG8661	MG8672	MG8683	MG8694



SOMBRERO CANOPY
10 ft x 10 ft / 3 x 3 m

L 10 ft | 3.0 m
W 10 ft | 3.0 m
H 8 ft | 2.4 m

		Roof			
		Sling Solar Roof	Aluminum Trellis Roof	Teak Trellis Roof	Retractable Roman Shade
Walls	Open	MG8695	MG8703	MG8711	MG8719
	Back Aluminum Trellis	MG8696	MG8704	MG8712	MG8720
	Back Teak Trellis	MG8697	MG8705	MG8713	MG8721
	Back Aluminum Trellis + 2 Side Curtains	MG8698	MG8706	MG8714	MG8722
	Back Teak Trellis + 2 Side Curtains	MG8699	MG8707	MG8715	MG8723
	Back Aluminum Trellis + 2 Side Curtains + Front Curtain	MG8700	MG8708	MG8716	MG8724
	Back Teak Trellis + 2 Side Curtains + Front Curtain	MG8701	MG8709	MG8717	MG8725
	Curtains on 4 sides	MG8702	MG8710	MG8718	MG8726

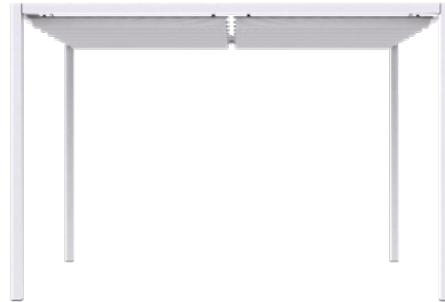

SOMBRERO CANOPY
10 ft x 12 ft / 3 x 3.6 m

L 10 ft | 3.0 m
W 12 ft | 3.6 m
H 8 ft | 2.4 m

		Roof			
		Sling Solar Roof	Aluminum Trellis Roof	Teak Trellis Roof	Retractable Roman Shade
Walls	Open	MG8727	MG8735	MG8743	MG8751
	Back Aluminum Trellis	MG8728	MG8736	MG8744	MG8752
	Back Teak Trellis	MG8729	MG8737	MG8745	MG8753
	Back Aluminum Trellis + 2 Side Curtains	MG8730	MG8738	MG8746	MG8754
	Back Teak Trellis + 2 Side Curtains	MG8731	MG8739	MG8747	MG8755
	Back Aluminum Trellis + 2 Side Curtains + Front Curtain	MG8732	MG8740	MG8748	MG8756
	Back Teak Trellis + 2 Side Curtains + Front Curtain	MG8733	MG8741	MG8749	MG8757
	Curtains on 4 sides	MG8734	MG8742	MG8750	MG8758

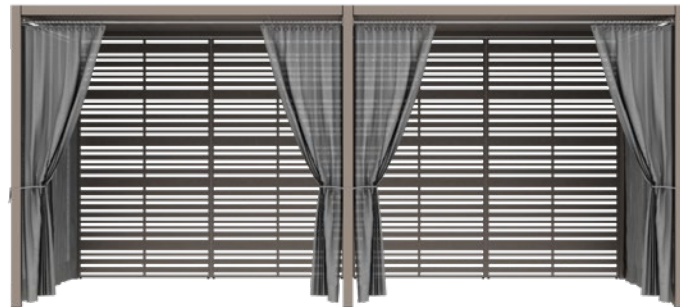

SOMBRERO CANOPY
10 ft x 18 ft / 3 x 5.5 m

L 10 ft | 3.0 m
W 18 ft | 5.5 m
H 8 ft | 2.4 m

		Roof			
		Sling Solar Roof	Aluminum Trellis Roof	Teak Trellis Roof	Retractable Roman Shade
Walls	Open	MG8759	MG8816	MG8777	MG8786
	Back Aluminum Trellis	MG8760	MG8817	MG8778	MG8787
	Back + 1 Wall Aluminum Trellis (indicate position)	MG8761	MG8770	MG8779	MG8788
	Back + 2 Walls Aluminum Trellis	MG8762	MG8818	MG8780	MG8789
	Back Teak Trellis	MG8811	MG8819	MG8781	MG8790
	Back + 1 Wall Teak Trellis (indicate position)	MG8812	MG8820	MG8782	MG8791
	Back + 2 Walls Teak Trellis	MG8813	MG8774	MG8783	MG8792
	Back Aluminum Trellis + 2 Side Curtains + Front Curtain	MG8814	MG8775	MG8784	MG8793
	Back Teak Trellis + 2 Side Curtains + Front Curtain	MG8815	MG8776	MG8785	MG8794



Size ft/m	Total Height	Head Clearance	Retractable Roman Shade	Maximum Length	Maximum Width	Frame Length (center to center)	Frame Width (center to center)	Head Clearance (curtain bar)	Pole Dimension
	inch / cm	inch / cm	inch / cm	inch / cm	inch / cm	inch / cm	inch / cm	inch / cm	inch / cm
SQUARE 8' x 8' 2.4 m x 2.4 m	96 / 244	93 / 236	89 / 226	96 / 244	96 / 244	93 / 236	93 / 236	91 / 231	3 / 8
RECTANGLE 8' x 16' 2.4 m x 4.8 m	96 / 244	93 / 236	89 / 226	192 / 488	96 / 244	94.5 / 240	93 / 236	91 / 231	3 / 8
	96 / 244	93 / 236	89 / 226	288 / 732	96 / 244	95 / 241	93 / 236	91 / 231	3 / 8
SQUARE 10' x 10' 3 m x 3 m	96 / 244	92.5 / 235	89 / 226	120 / 305	120 / 305	116.5 / 296	116.5 / 296	90.5 / 230	3.5 / 9
RECTANGLE 10' x 12' 3 m x 3.6 m	96 / 244	92.5 / 235	89 / 226	144 / 366	120 / 305	140.5 / 357	116.5 / 296	90.5 / 230	3.5 / 9
	96 / 244	92.5 / 235	89 / 226	216.5 / 550	120 / 305	216.5 / 550	116.5 / 296	90.5 / 230	3.5 / 9

FLOOR MOUNTING (CONCRETE / STONE)



FLOOR MOUNTING (DECKING)

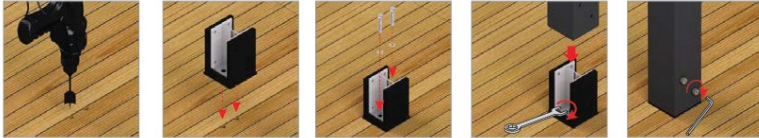

FLOOR MOUNTING (CONCRETE, BELOW SURFACE)

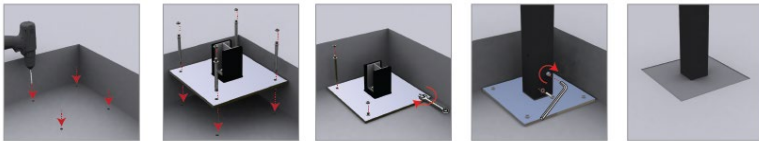

*Available by Request

REGULAR COLOR OPTIONS

FRAME

Premium
Powder Coated Aluminum
Ultra Durable

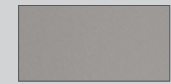
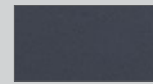
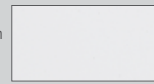

Standard
Powder Coated Aluminum
Gloss

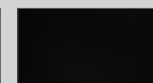
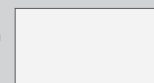

SHEER CURTAIN

Olefin Polyester



RETRACTABLE ROMAN SHADE (Not suitable for windy areas)

Sunbrella Category - E

SLING SOLAR ROOF

Betyline Category - K

TEAK TRELLIS

Recycled Teak - Smooth



i See back for information & color swatches

CUSTOMIZATION

We do accept custom orders for all Sombrero Canopies.

- Submit floor dimensions
- Submit floor specifications
- Submit requested configurations

SOMBRERO

CANOPY MULTI POSITION SLING (STAINLESS STEEL)

268

This version of the SOMBRERO canopy creates a contemporary aesthetic. The multi position sling roof / wall offers privacy and shade. Suitable for luxurious hospitality and residential projects. Not suitable in areas with extreme winds, rooftops or beachfront properties.







SOMBRERO CANOPY MULTI-POSITION SLING

8 ft x 8 ft / 2.4 x 2.4 m

L 8 ft | 2.4 m
W 8 ft | 2.4 m
H 8 ft | 2.4 m

Walls	Multi-position Sling	MG8608
	Multi-position Sling + Back Sling (fixed)	MG8851
	Multi-position Sling + Back Teak Trellis (round slats)	MG8852
	Multi-position Sling + Back Driftlook	MG8610
	Add extension 8 ft x 8 ft (2.4 x 2.4 m)	MG8854



SOMBRERO CANOPY MULTI-POSITION SLING

10 ft x 10 ft / 3 x 3 m

L 10 ft | 3.0 m
W 10 ft | 3.0 m
H 8 ft | 2.4 m

Walls	Multi-position Sling	MG8855
	Multi-position Sling + Back Sling	MG8856
	Multi-position Sling + Back Teak Trellis	MG8857
	Multi-position Sling + Back Driftlook	MG8858
	Add extension 10 ft x 10 ft (3 x 3 m)	MG8859



SOMBRERO CANOPY MULTI-POSITION SLING

10 ft x 12 ft / 3 x 3.6 m

L 10 ft | 3.0 m
W 12 ft | 3.6 m
H 8 ft | 2.4 m

Walls	Multi-position Sling	MG8860
	Multi-position Sling + Back Sling	MG8861
	Multi-position Sling + Back Teak Trellis	MG8862
	Multi-position Sling + 1/2 Back Teak Trellis	MG8863
	Multi-position Sling + Back Driftlook	MG8864
	Multi-position Sling + 1/2 Back Driftlook	MG8865
	Add extension 10 ft x 12 ft (3 x 3.6 m)	MG8866



SOMBRERO CANOPY MULTI-POSITION SLING

12 ft x 12 ft / 3.6 x 3.6 m

L 12 ft | 3.6 m
W 12 ft | 3.6 m
H 8 ft | 2.4 m

Walls	Multi-position Sling	MG8632
	Multi-position Sling + Back Sling	MG8868
	Multi-position Sling + Back Teak Trellis	MG8869
	Multi-position Sling + 1/2 Back Teak Trellis	MG8870
	Multi-position Sling + Back Driftlook	MG8871
	Multi-position Sling + 1/2 Back Driftlook	MG8872
	Add extension 12 ft x 12 ft (3.6 x 3.6 m)	MG8873

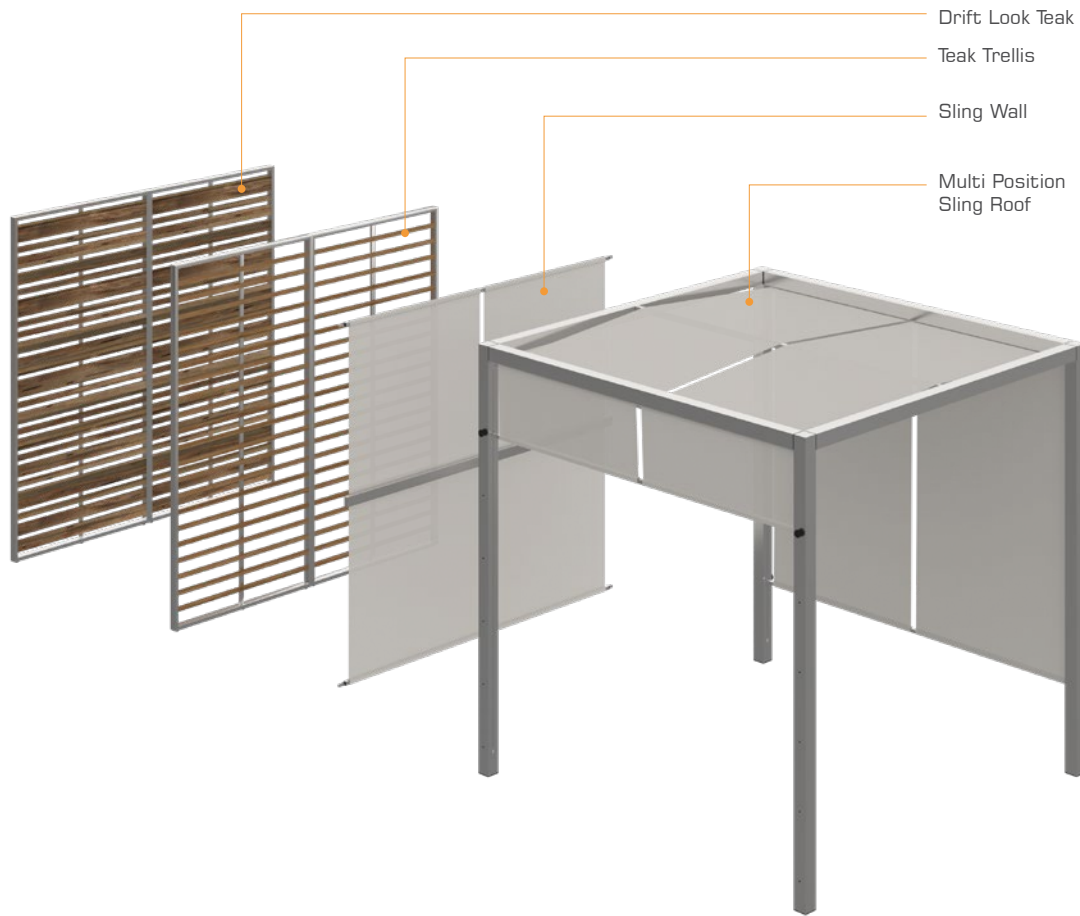

FLOOR MOUNTING (CONCRETE / STONE)

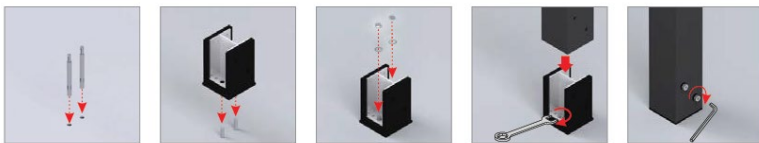

FLOOR MOUNTING (DECKING)

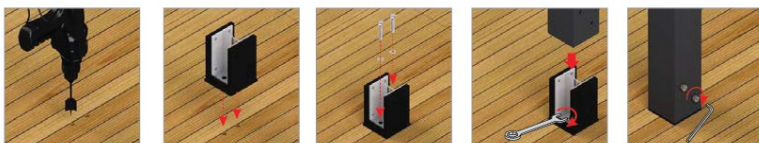

FLOOR MOUNTING (CONCRETE, BELOW SURFACE)



*Available by Request

REGULAR COLOR OPTIONS

FRAME

Stainless Steel 304
Hairline



Premium Powder Coated
Stainless Steel
Ultra Durable



Standard Powder Coated
Stainless Steel
Gloss

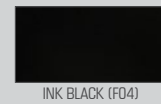
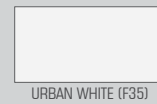

BACK

Teak Trellis

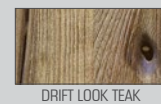

SLING SOLAR ROOF

Batyline Category - K

i See back for information & color swatches

SOMBRERO

CABANA

272

SOMBRERO cabanas create privacy, shade and protect from light rains. Suitable for hospitality and residential.

In case of heavy winds or storms and snow, remove shade to avoid damage. This cabana is not recommended in areas with exposure to extreme winds or tornadoes.

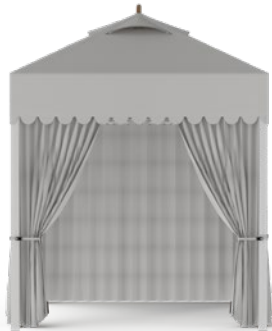

SOMBRERO CABANA
8 ft x 8 ft / 2.4 x 2.4 m
MG8874

L 8 ft | 2.4 m
W 8 ft | 2.4 m
H 10.8 ft | 3.3 m



SOMBRERO CABANA
10 ft x 10 ft / 3 m x 3 m
MG8875

L 10 ft | 3.0 m
W 10 ft | 3.0 m
H 10.8 ft | 3.3 m

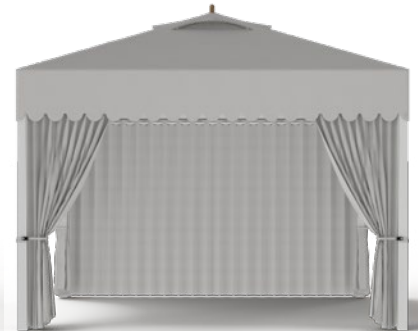

SOMBRERO CABANA
10 ft x 12 ft / 3 x 3.6 m
MG8876

L 10 ft | 3.0 m
W 12 ft | 3.6 m
H 10.8 ft | 3.3 m

	Size ft/m	Total Height	Head Clearance	Maximum Length	Maximum Width	Frame Length (center to center)	Frame Width (center to center)	Pole Dimension
		inch / cm	inch / cm	inch / cm	inch / cm	inch / cm	inch / cm	inch / cm
SQUARE	8' x 8' 2.4 m x 2.4 m	130 / 330	77 / 196	97 / 246	96 / 244	93 / 236	93 / 236	3 / 8
	10' x 10' 3 m x 3 m	130 / 330	77 / 196	121 / 307	121 / 307	116.5 / 296	116.5 / 296	3.5 / 9
RECTANGLE	10' x 12' 3 m x 3.6 m	130 / 330	77 / 196	145 / 368	121 / 307	140.5 / 357	116.5 / 296	3.5 / 9

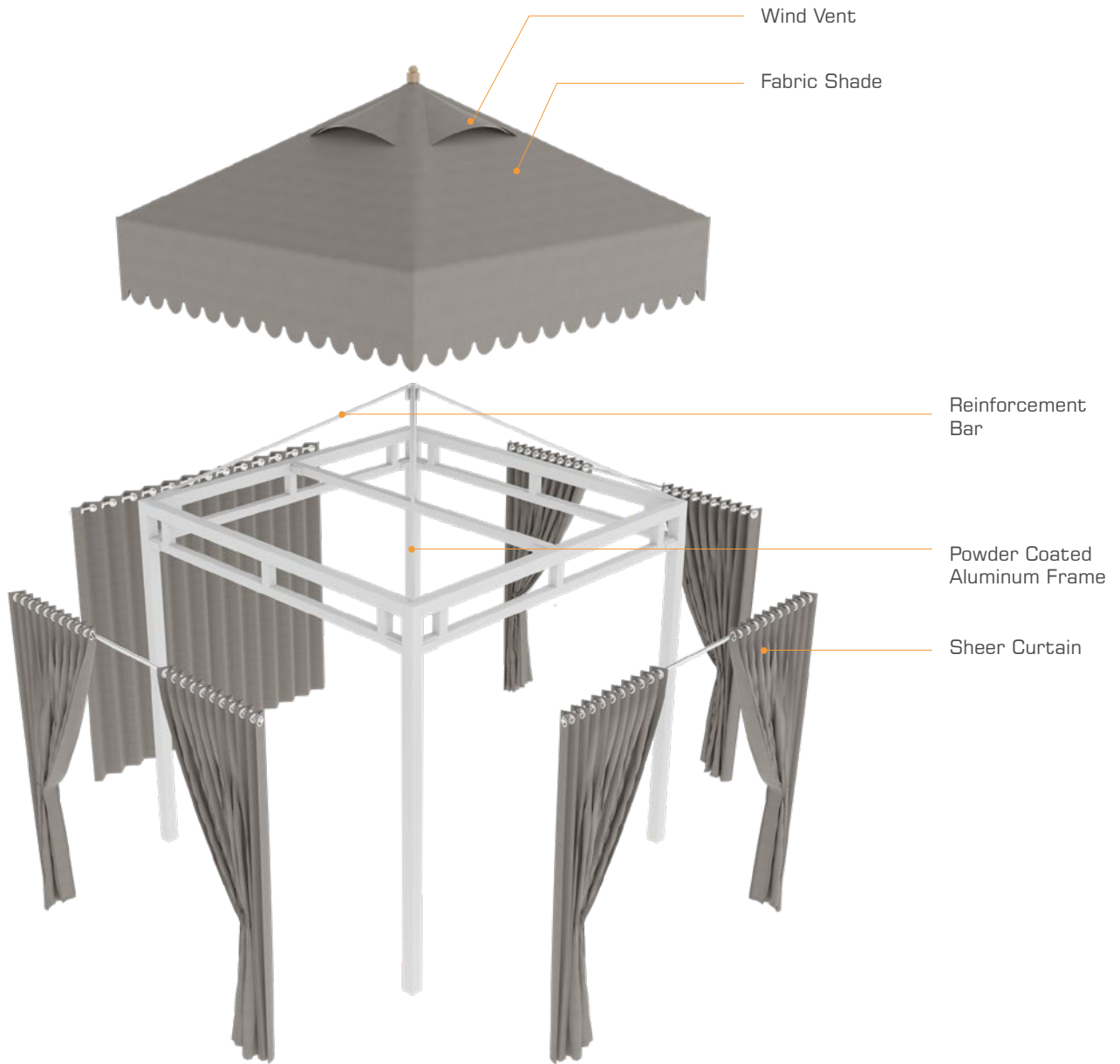

REGULAR COLOR OPTIONS

FRAME

Premium Powder Coated Aluminum - Ultra Durable

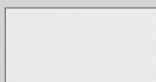

COTTON (F50)



IRON BLACK (F49)

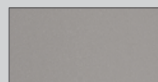

CHAMPAGNE (F69)

Standard Powder Coated Aluminum - Gloss

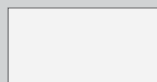

URBAN WHITE (F35)

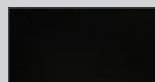

INK BLACK (F04)

CURTAIN & WIND VENT

Sunbrella Canvas Category - E



WHITE (C49)



TAUPE (C50)

i See back for information & color swatches

SOMBRERO

SHADE STRUCTURES

274

Time for that resort feeling!
Outdoor rooms, with lounge or dining function.
Available in a wide range of colors.

Suitable for hospitality and residential.
The cover protects against the sun and light rains.

In case of heavy winds or storms and snow,
remove shade & cushions to avoid damage.

Optional floor mounting for public areas.





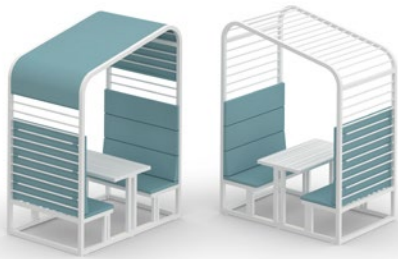

SOMBRERO Dining Booth
(Aluminum Trellis)

MG8140

L 6 ft | 1.8 m
W 4 ft | 1.2 m
H 7.9 ft | 2.4 m

* Includes Sunbrella Shade, Sunbrella Cushion
(Quick Dry Foam Core)

* Cushion thickness : 2" / 5 cm

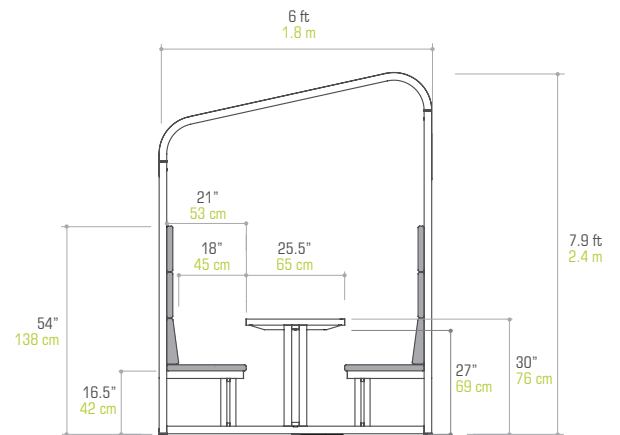

SOMBRERO Lounge Booth
(Aluminum Trellis)

MG8137

L 9 ft | 2.7 m
W 5.5 ft | 1.6 m
H 7.9 ft | 2.4 m

* Includes Sunbrella Shade, Sunbrella Cushion
(Quick Dry Foam Core)

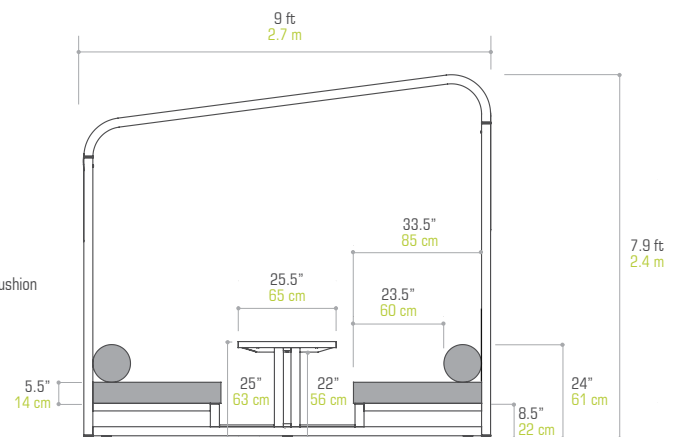

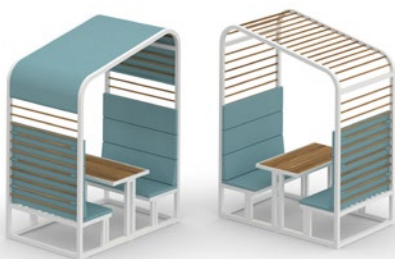

SOMBRERO Dining Booth
(Teak Trellis & Table Top)

MG8170

L 6 ft | 1.8 m
W 4 ft | 1.2 m
H 7.9 ft | 2.4 m

* Includes Sunbrella Shade, Sunbrella Cushion
(Quick Dry Foam Core)

* Cushion thickness : 2" / 5 cm

MATERIAL INFO

FRAME // TRELLIS+TABLE TOP (MG8140 / MG8137)

Premium Powder Coated Aluminum - Ultra Durable

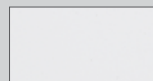

COTTON (F50)



IRON BLACK (F49)

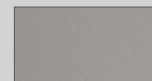

CHAMPAGNE (F69)

Standard Powder Coated Aluminum - Gloss

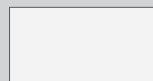

URBAN WHITE (F35)

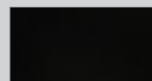

INK BLACK (F04)

TRELLIS+TABLE TOP (MG8170 / MG8171)

Recycled Teak - Smooth Sanded (T30)

SHADE

Sunbrella Category E / G

CUSHION

Quick dry foam with Sunbrella cover

i See back for information & color swatches



SOMBRERO Lounge Booth
(Teak Trellis & Table Top)

MG8171

L 9 ft | 2.7 m
W 5.5 ft | 1.6 m
H 7.9 ft | 2.4 m

* Includes Sunbrella Shade, Sunbrella Cushion
(Quick Dry Foam Core)

SOMBREIRO

PERSONAL SHADE

278



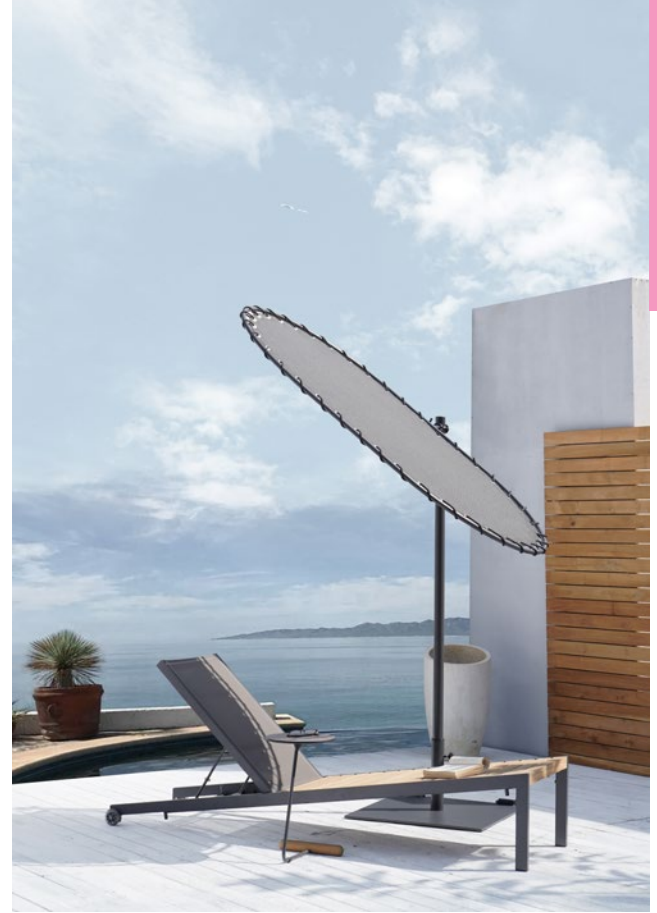

SOMBRERO Personal Shade
MG15924

W 71" | 180 cm
D 39.5" | 100 cm
H 81.5" | 207 cm

NOTE : Heavy item, suitable for windy areas
Optional floor-mount



MATERIAL INFO

BASE / FRAME

Standard Powder Coated Galvanized Steel - Gloss

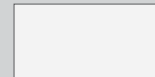

URBAN WHITE (F35)

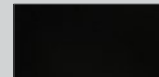

INK BLACK (F04)

Premium Powder Coated Galvanized Steel - Ultra Durable

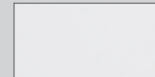

COTTON (F50)

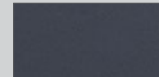

IRON BLACK (F49)

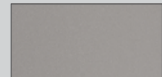

CHAMPAGNE (F69)

SHADE

Sunbrella Category E / G

i See back for information & color swatches

PREMIUM OUTDOOR PILLOWS

280

Premium Outdoor Pillows offer excellent back or lumbar support. Pillow covers, made of Sunbrella or Olefin fabric can be easily removed for handwashing.

Pillow inserts are made of 100% Hilon Dacron in a water repellent taffeta polyester liner.





16"
40 cm

24"
60 cm

BOX Pillow 24"x16" / 60 x 40 cm
(with contrasting piping)
SUPI01



14"
35 cm

18"
45 cm

BOX Pillow 18" x 14" / 45 x 35 cm
(with contrasting piping)
SUPI02



16"
40 cm

24"
60 cm

BULLNOSE Back Pillow
24" x 16" / 60 x 40 cm
SUPI03



14"
35 cm

18"
45 cm

BULLNOSE Lumbar Pillow
18" x 14" / 45 x 35 cm
SUPI04



DECO
cover : Sunbrella / Olefin

DECO
(with piping)
cover : Sunbrella
piping : Sunbrella / Stamskin

BULLNOSE
cover : Sunbrella / Olefin

BOX
(with piping)
cover : Sunbrella
piping : Sunbrella / Stamskin



24"
60 cm

24"
60 cm

DECO Pillow 24" x 24" / 60 x 60 cm
(with contrasting piping)
SUPI05



20"
50 cm

20"
50 cm

DECO Pillow 20" x 20" / 50 x 50 cm
(with contrasting piping)
SUPI07



16"
40 cm

16"
40 cm

DECO Pillow 16" x 16" / 40 x 40 cm
(with contrasting piping)
SUPI09



24"
60 cm

24"
60 cm

DECO Pillow 24" x 24" / 60 x 60 cm
SUPI06



20"
50 cm

20"
50 cm

DECO Pillow 20" x 20" / 50 x 50 cm
SUPI08



16"
40 cm

16"
40 cm

DECO Pillow 16" x 16" / 40 x 40 cm
SUPI10

HANDMADE TEXTURED PILLOWS

282

Handmade Textured Pillows are available in five different designs and multiple color options. These decorative throw pillows can remain outside during light rain and are easily stored overnight when not in use.

Carefully designed MAMAGREEN pillows are easy to mix and match with any collection and offer countless design possibilities.



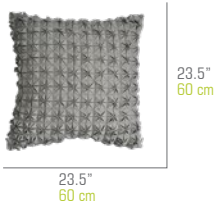

Flower Pillow
MG8229



Flower Pillow
MG8228

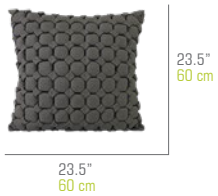

Bee Pillow
MG8412

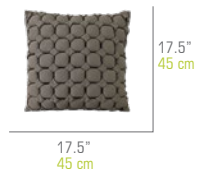

Bee Pillow
MG8411

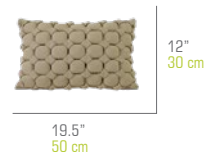

Bee Pillow
MG8413



Weave Pillow
MG8227



Weave Pillow
MG8226

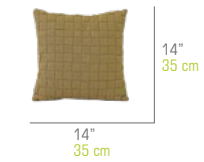

Weave Pillow
MG8225



Weave Pillow
MG8410



Fringe Pillow
MG8224



Fringe Pillow
MG8222



Fringe Pillow
MG8223



Loop Pillow
MG8416



Loop Pillow
MG8414

Root

Masterpieces designed by nature.



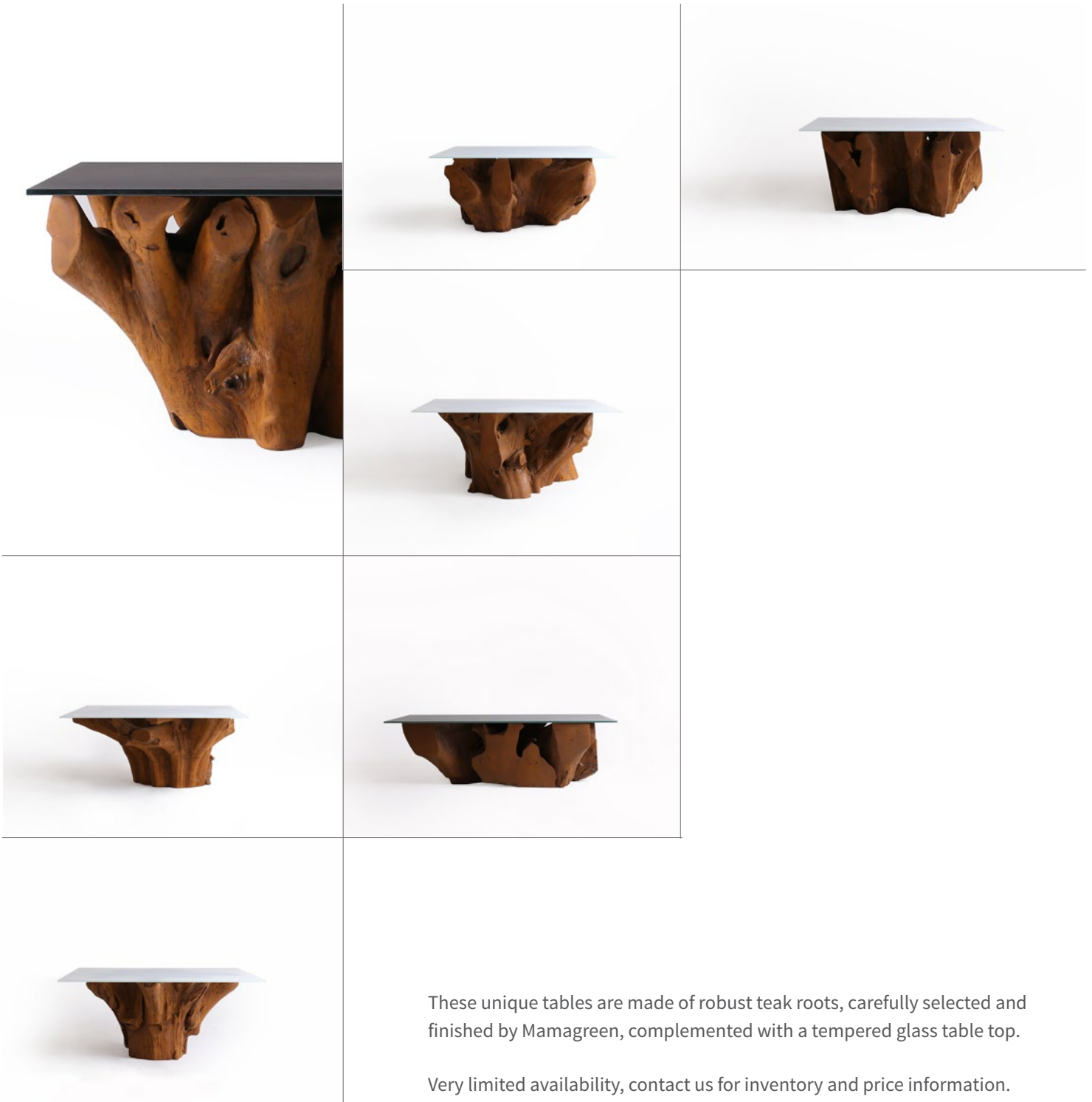

These unique tables are made of robust teak roots, carefully selected and finished by Mamagreen, complemented with a tempered glass table top.

Very limited availability, contact us for inventory and price information.

Protective Covers

PREMIUM winter-ready covers **Enabling your indoor lifestyle; to move outside**

All weather solutions, effective for precipitation rates of up to 15 mm/hour.

- SURLAST® textile, made in the USA by Glen Raven
- 100% solution dyed polyester
- Heavy duty 235 gr/m² - 7 oz/yd²
- A special water-repelling inside cover for sewing seams
- High frost, water, mold and mildew resistance
- Suitable for use with all MAMAGREEN textiles / materials

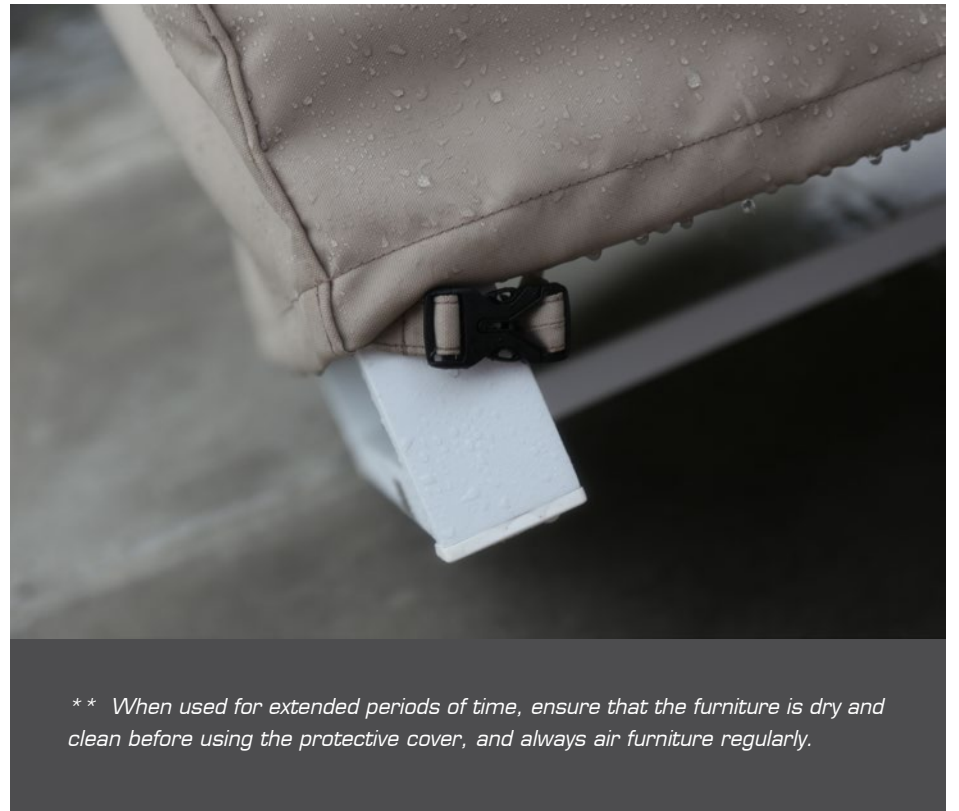

*** When used for extended periods of time, ensure that the furniture is dry and clean before using the protective cover, and always air furniture regularly.*



Custom-fit for all sectional sofas



Protective covers for sofas



Custom-fit for all dining sets



Protective covers for table top only



Protective covers for stacking chairs



Protective covers for lounge chairs



Materials

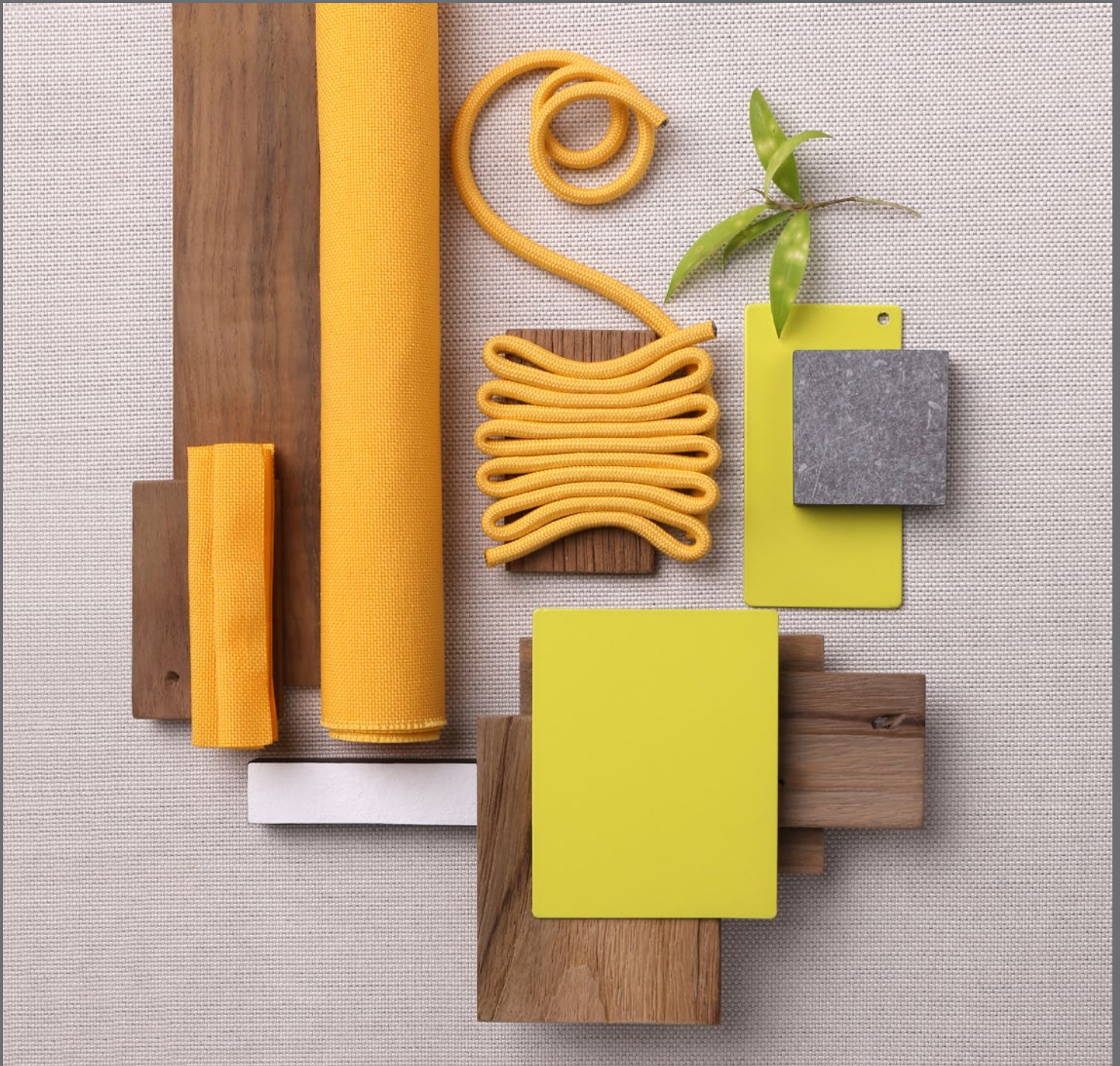

OUTDOOR SPACE SUGGESTIONS Extend the lifetime of your furniture

It is our goals to give you as much possible options and advise, so you can enjoy your furniture for a very long period.

Tip : For use on grass or sand or uneven areas, advised to opt for sled legs, instead of post legs.

Tip : Tables with self-levelling gliders are available in certain collections.

OUTDOOR (FULLY EXPOSED)

FRAME :

- Ultra Durable Powder-coated Aluminum / Stainless Steel
 - Teak
- 304 Stainless Steel

Tip : Select furniture pieces > 20 Lb / 9 Kgs in windy areas.

Tip : Use protective covers when not in use (Do not cover dirty or wet furniture for extended periods of time).

Clean and maintain your furniture regularly.



MARINE / COASTAL ENVIRONMENTS

FRAME :

- 316 Stainless Steel
- Ultra Durable Powder-coated Aluminum
- Teak

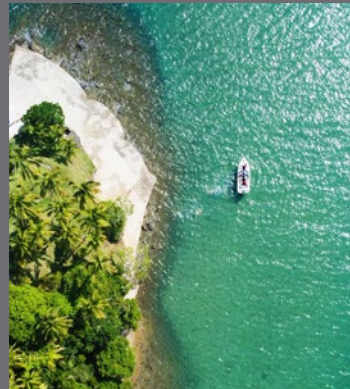

Tip : Select furniture pieces > 20 Lb / 9 Kgs.

Tip : Use protective covers when not in use (after cleaning).

Tip : Store cushions inside if possible.

Clean and maintain your furniture very regularly.



COVERED (SEMI-OPEN AREAS)

FRAME :

- Powder-coated Aluminum / Stainless Steel
 - Teak
- Galvanized Steel
- 304 Stainless Steel

Tip : Let the furniture breath, avoid covering for long periods. Cleaning will extend the beautiful looks of the furniture.

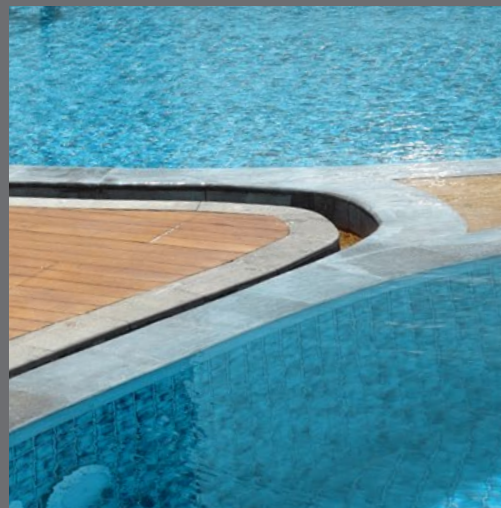

POOL FURNITURE

FRAME :

- Ultra Durable Powder-coated Aluminum
- Teak
- 316 Stainless Steel

Tip : Use mesh textiles as much as possible.

Tip : Use protective covers when not in use

(Do not cover dirty or wet furniture for extended periods of time).

Clean and maintain your furniture regularly.



Teak (scientific name *Tectona Grandis*) is a premium hardwood, native to South East Asia, with a very high natural oil content. Highly resistant to rotting, fungi, warping and water absorption, teak remains durable even in an extreme climate.

Exposed to sunlight, the color of teak will gradually change from honey brown to silver grey. This weathering does not affect the performance or quality of the timber. Various products are on the market to clean, protect or restore teak.

PREMIUM TEAK

Grade A sustainably harvested teak is carefully sourced from responsibly managed and fully certified teak farms in Java. Smooth sanded teak looks best with simple, regular cleaning, especially if the furniture is placed under trees or used regularly for dining. Wash with a mild household soap and lukewarm water to avoid mildew, caused organically by dirt gathering in the grains and notches.

All Mamagreen teak furniture is treated with Golden Care “Teak Shield”, whose protective layer protects against marks, without stopping the silver grey weathering process.



T24 PREMIUM TEAK SMOOTH SANDED



WEATHERED SILVER GREY





RECYCLED TEAK

When possible, we use reclaimed teak from abandoned buildings. Recycled teak has character : From holes where bolts were used, to nail holes, damage from hinges and other imperfections; all combine to give recycled teak its unique look. We do not attempt to hide these characteristics; we feel that each aesthetic imperfection in the wood adds to the exceptional feeling in the furniture.

DRIFT-LOOK TEAK

MAMAGREEN drift-look teak is showcasing both natural and handmade distress marks. This 'extra-distressed', recycled teak is then finished, either 'as original', or in rich espresso. Highly contemporary, texture-rich Drift-look teak is used in our iconic AIKO Collection.

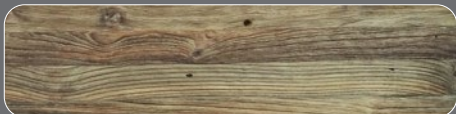

T31 RECYCLED TEAK BRUSHED



F37 ESPRESSO FINISH



T30 RECYCLED TEAK SMOOTH SANDED

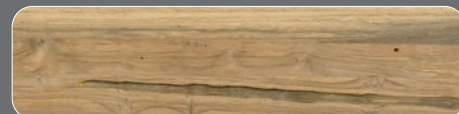

F36 ORIGINAL FINISH

HPL

Italian manufactured High Pressure Laminate (HPL) is an eye-catchingly modern element for outdoor furniture, which will complement any residential or commercial space. Advanced technological manufacturing involves bonding sheets of kraft paper and aluminum with animoplastic resins, using high pressure and heat.

HPL tops do not require particular maintenance that goes beyond normal cleaning with hot water and liquid soap. Common detergents and solvents, thinners and steam can be used for stubborn stains. Avoid, however, any alkaline or bleach products. Stains on Alpes White could be more visible and a bit more difficult to clean, compared to multi colored stone motives. As HPL has anti-static capacities, table tops do not attract dust. Wax or wax based products should not be applied as protection.

Extreme UV-exposure will cause some discoloration, without impacting the structural integrity of this material; protective covers will extend the beautiful look for many years.

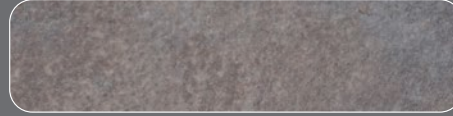

T52
LATERITE



T37
SLATE

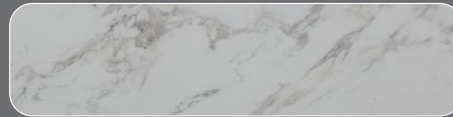

T61
CARRARA WHITE

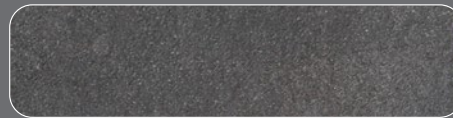

T54
VOLCANIC ASH

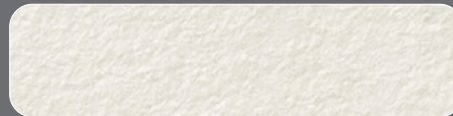

T38
ALPES WHITE



T62
CARRARA BLACK



T39
SCRATCHED GREY

MAMAGREEN METAL FRAMES

INTEGRAL DESIGN

MAMAGREEN furniture pieces are, for the most part, designed around a strong, durable metal structure. Made to perform well, our metal frames come in different textures and colors that withstand the challenges of commercial and residential use.

ALUMINUM

Rigid, yet light weight, alloy 6063 aluminum is a sturdy metal, very well suited for outdoor furniture, with structural anti-rust capacities. Powder coating protects against surface corrosion. Applying electrostatically charged dry paint, baked in an oven, the paint becomes a protective layer with a uniform color and texture.

Powder coated frames can be easily cleaned with a soft brush and soapy water. To handle the occasional scratch mark, we provide touch up kits in a similar color.

STAINLESS STEEL

Unmatched in strength and beauty, stainless steel frames are extremely suitable for most outdoor environments.

We generally use 304 stainless steel, an iron alloy with a high corrosion resistance, thanks to its unique chrome addition and nickel content, in a hairline finish, with subtle continuous, uni-directional grind marks. This finish will last well, when regularly cleaned, however, susceptible to tea staining is not advised in a marine environment, exposed to chlorinated or salt water.

A number of our collections are available with powder coated 304 stainless steel frames. This finish will perform very well - also in a coastal environment - protected by a UV resistant, durable, low maintenance powder coating on top of a strong epoxy primer.

Marine grade 316 stainless steel in a shiny mirror look finish is used in the ALBATROSS Collection, and available for custom projects, such as beach front properties or cruise ships.



304 HAIRLINE FINISH

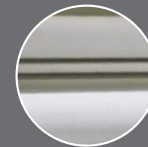

316 MIRROR POLISHED

GALVANIZED STEEL

Powdercoated Galvanized Steel, protected with a zinc layer, has high corrosion resistance. Furniture made with a galvanized steel frame is very sturdy, and suitable for windy areas such as rooftops, but not advised for beachfront properties.

The industrial production process creates a random textured surface which is part of the design.

PREMIUM POWDER COATING COLORS

ULTRA DURABLE

Application : All Mamagreen metal frames
 Note : Contract and Residential Use



NEW
F69
 CHAMPAGNE



F50
 COTTON

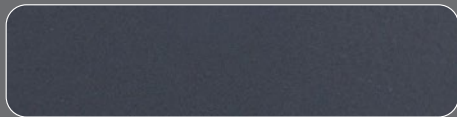

F49
 IRON BLACK

VINTAGE METALS

Application : Round Tubular Aluminum / Galvanized Steel
 Note : Intentional Imperfections



NEW
F65
 NEO BRONZE
 (hammered)



F42
 NEO COPPER



F41
 NEO BRASS

STANDARD POWDER COATING COLORS

GLOSS

Application : All Mamagreen metal frames
 Note : Not advised for marine environments



F35
 URBAN WHITE

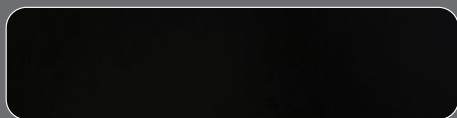

F04
 INK BLACK



F15
 FIRE ENGINE RED



F16
 INDUSTRIAL YELLOW



F59
 AZURE

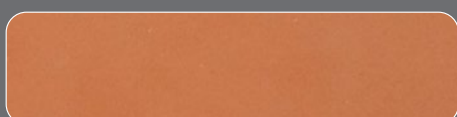

F51
 ORANGE CORAL

SAND

Application : Aluminum / Stainless Steel / Galvanized Steel
 Note : Not advised for table tops / sandy areas / cabanas Residential only

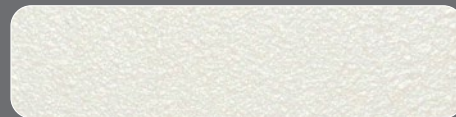

F03
 WHITE

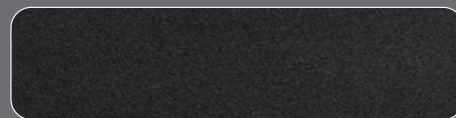

F05
 BLACK



F07
 TAUPE



F09
 ANTHRACITE

WICKER | FLAT WEAVE

Our design team created five distinct color patterns for the Daisy Mae range. Mix and match with our powder coating and textile colors, create a look that blends in or stands out.

MAMAGREEN's wicker, made from high density polyethylene, is highly color fast and extremely weather resistant (suitable both in tropical and cold environments).

Carefully handwoven, wicker furniture pieces are durable, non-toxic, recyclable and easy to clean with liquid soap.



W27 BREEZE 



W28 FROST BLUE 

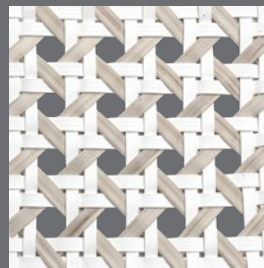

W35 ALABASTER 



W26 JAVA

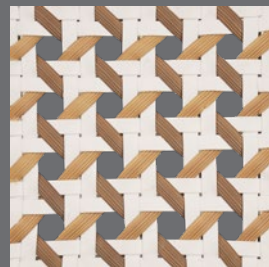

W25 MACCHIATO



FIRE RETARDANT
IMO Res. A. 652(16) compliant

SYNTHETIC WICKER

MAMAGREEN's wicker is made from high density polyethylene and is extremely weather resistant, suitable both in tropical and cold environments. Carefully handwoven, wicker furniture pieces are durable, non-toxic, recyclable and easy to clean with liquid soap.

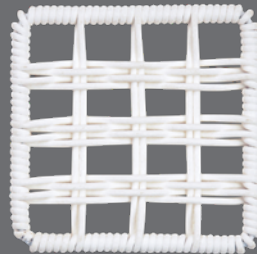

W13 SNOW WHITE

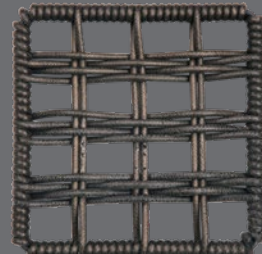

W09 AMAZON

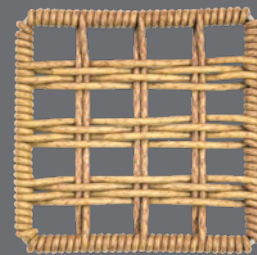

W10 HONEY

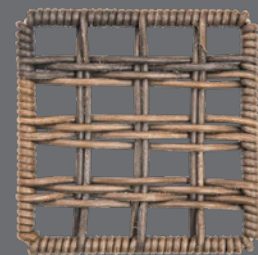

W14 PEPPER

TWITCHELL TEXTILES

Made in the USA by Twitchell Corp

Ideal for heavy duty upholstered chairs and lounge frames, these textiles are made of stiff PVC coated polyester mixed with polyolefin.

The Leisuretex closely woven yarn, with water repellent back-layer increases the outstanding all-weather benefits of this robust, durable technical textile.

Furniture made from Twitchell fabrics will last many years, though a minimal deterioration of the olefin fibers may occur after time. This synthetic textile is easy to clean with a water / liquid soap mix and a soft scrubber.

LEISURETEX®

For durable upholstered frames



U29
WHITE
520 gr/m2



U30
BLACK
520 gr/m2



U31
GREY
520 gr/m2

TEXTILENE®

For sling and upholstery



S23
GREEN BARCODE
525 gr/m2



FIRE RETARDANT
CS 191-53 & CA 117E



S24
RED BARCODE
525 gr/m2



S21
ORANGE BARCODE
525 gr/m2



U27
PINSTRIPE SAND
440 gr/m2

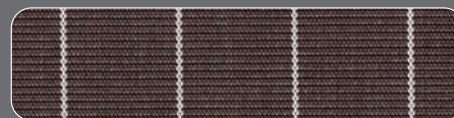

U28
PINSTRIPE MOCCA
440 gr/m2



S25
ROYAL BLACK
740 gr/m2

STAMSKIN® Upholstery

Designed in France,
 manufactured in Switzerland by Serge Ferrari
 Application : upholstered frames

This water-tight faux leather fabric offers excellent resistance over time. Versatile and durable, this soft feeling marine-grade artificial leather has a high UV protection and anti-soil, fungal and microbial treatment. Cleaning can be done using the Serge Ferrari 500 Cleaner (or a similar PH neutral textile detergent).

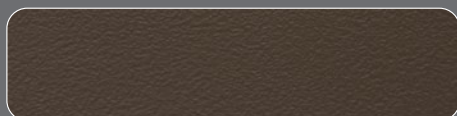

NEW
U40
 BISON
 780 gr/m²

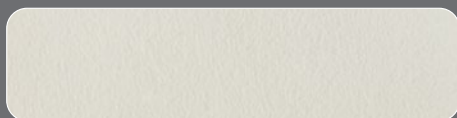

U33
 WHITE
 780 gr/m²

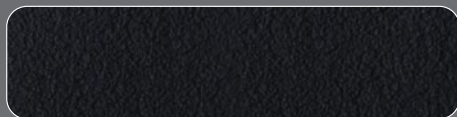

U34
 BLACK
 780 gr/m²



U35
 GREY TAUPE
 780 gr/m²



U37
 PURPLE
 780 gr/m²



U39
 ORANGE
 930 gr/m²



U36
 LIME
 780 gr/m²



FIRE RETARDANT
 IMO 2010 FTP Code Part 8 compliant

BATYLINE® LOUNGE Upholstery

Designed and manufactured in France
 by Serge Ferrari
 Application : outdoor upholstery

This all-weather, closely woven mesh has excellent UV resistance, extreme tear strength and FIRE RETARDANT specifications. Bringing the indoor look outdoors, this durable textile has incomparable seating comfort. Cleaning can be done using the Serge Ferrari 500 Cleaner (or a similar PH neutral textile detergent).



U18
 WHITE
 450 gr/m²



U19
 BLACK
 450 gr/m²

Rope

ROPE

MAMAGREEN's rope is made of olefin, an Oeko-Tex certified synthetic fabric and has high weatherability and anti-mildew capacities. Colors can weather slightly yet remain vibrant for an extended period of time. Ideal to clean stains and spills as soon as possible with a dry cloth. Regular cleaning with soapy lukewarm water, will extend the good looks of the furniture pieces.



W36 BARLEY
NEW



W33 RAVEN



W22 TRUFFLE



W20 WILLOW



W24 CORAL

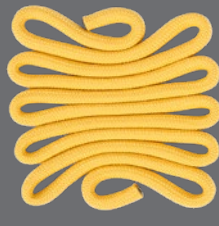

W34 CANARY



W32 PEARL



W23 NAVY

KEOPS® Webbing

Made in France by Serge Ferrari

Blended with natural hemp fiber, a supremely comfortable, high end option for webbing. Cleaning can be done using the Serge Ferrari 500 Cleaner (or a similar PH neutral textile detergent).

Applications :
Albatross, Ekka

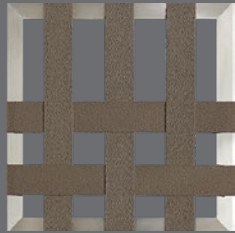

W12 COCOA

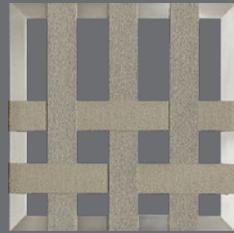

W11 DUNE

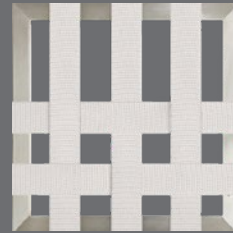

W21 HERON WHITE



BATYLINE® SLING

Designed and manufactured
in France by Serge Ferrari

Premium grade UV resistant mesh textile, with an extreme tear and tensile strength, available in a wide range of vivid and neutral colors. Furniture using Batyline Sling will give seating pleasure for many years, in any environment. Cleaning can be done using the Serge Ferrari 500 Cleaner (or a similar PH neutral textile detergent).

CATEGORY K - Standard



S01
WHITE
(500 gr/m2)

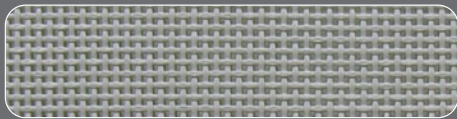

S02
GREY
(500 gr/m2)



S03
LIGHT TAUPE
(500 gr/m2)



S04
DARK TAUPE
(500 gr/m2)



S05
BLACK
(500 gr/m2)



S28
SASSY GREEN
(500 gr/m2)

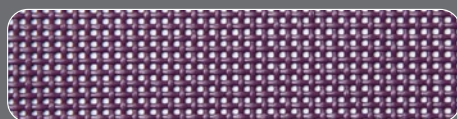

S07
PURPLE
(500 gr/m2)

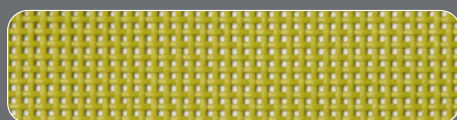

S08
LIME
(500 gr/m2)



S09
ARUBA
(500 gr/m2)



S10
ORANGE
(500 gr/m2)



S06
SILVER
(500 gr/m2)



CATEGORY M - Hemp

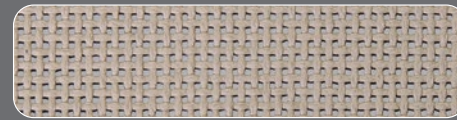

S13
HEMP
(560 gr/m2)



Batyline Canatex Hemp is a time-tested all weather mesh using hemp combined with synthetic fibers, woven in a radically novel way.

CATEGORY L - Abstract



S15
GEM BLUE
(500 gr/m2)



S16
GEM TAUPE
(560 gr/m2)



S17
GEM CREAM
(560 gr/m2)



FIRE RETARDANT
IMO 2010 FTP Code Part 8 compliant

TEXTILENE® SLING

Made in the USA by Twitchell Corp

Ideal for various mesh applications, these textiles are made of stiff PVC coated polyester. We offer 3 Navaho style "Stripe" patterns, 2 Pinstripe patterns and a gold accented pattern "Royal Black".

Textilene is a durable, versatile fabric. Tear strength and tensile capacities are very high, making it suitable in any outdoor environment. Not affecting the quality of the textile, striped yarn colors may weather slightly over extended periods of time. This synthetic textile is easy to clean with a water / liquid soap mix and a soft scrubber.

TEXTILENE® STRIPES



S23
GREEN BARCODE
525 gr/m2



S24
RED BARCODE
525 gr/m2

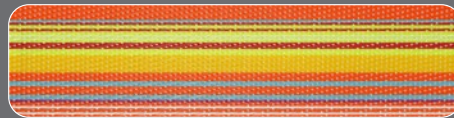

S21
ORANGE BARCODE
525 gr/m2



U27
PINSTRIPE SAND
440 gr/m2

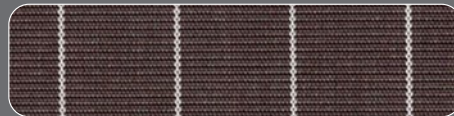

U28
PINSTRIPE MOCCA
440 gr/m2

TEXTILENE® SPECIALS



S25
ROYAL BLACK
740 gr/m2

Textilene Royal Black contains an elegant gold look accent and is heavier than regular Textilene.



FIRE RETARDANT
CS 191-53 & CA 117E

SUNBRELLA®

Design + Performances

100% Sunbrella® solution dyed acrylic, a dependable fabric, is the perfect choice for outdoor cushions. Yarns are finished with water repellent coating, reducing water absorbency. Extremely fade resistant and easy to clean, Sunbrella® has sublime anti-tear and tensile strength specifications, facilitating intensive outdoor usage. Sunbrella® is a USA based company, manufacturing performance outdoor textiles since the 1960's.

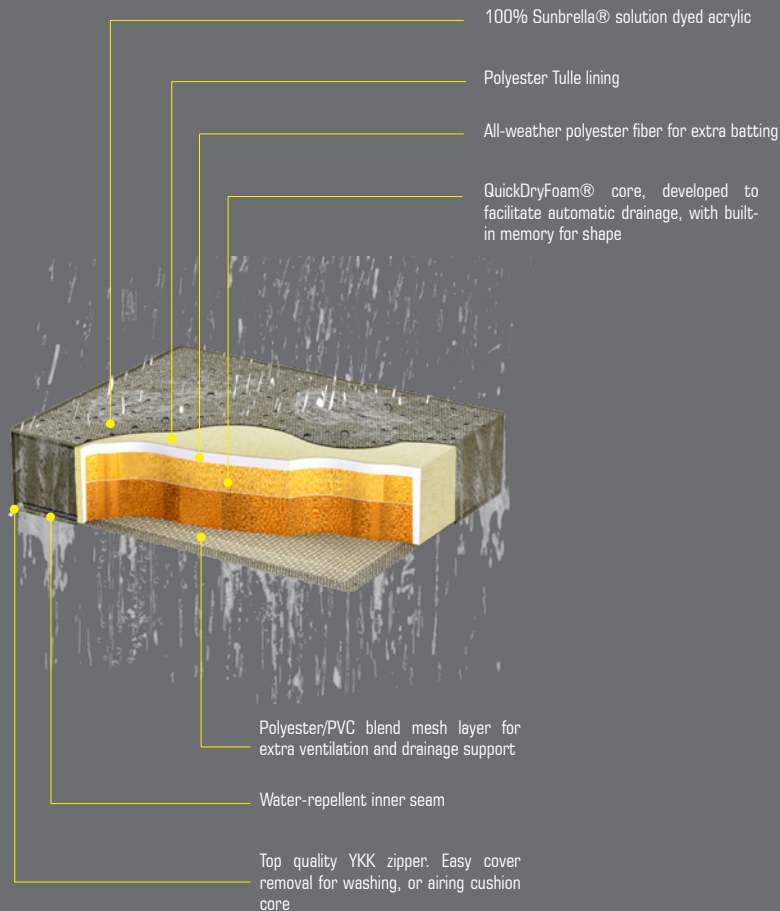

CATEGORY E - Canvas



C48
BLACK
260 gr/m2



C49
WHITE
260 gr/m2



C50
TAUPE
260 gr/m2

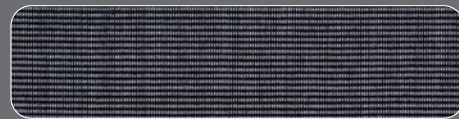

C54
COAL
260 gr/m2

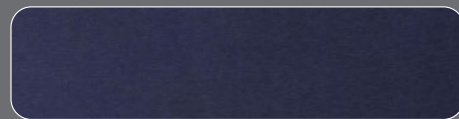

C100
NAVY BLUE
260 gr/m2



C98
CORAL
240 gr/m2



C52
MINERAL BLUE
260 gr/m2



C53
TEAK
260 gr/m2

CATEGORY G - Specials



NEW

C109
HERITAGE GRANITE
350 gr/m²

50%



C61
HERITAGE DENIM
350 gr/m²

50%



C85I
MARBLE GLACIER ICE
345 gr/m²



C85B
MARBLE GLACIER BLUE
345 gr/m²

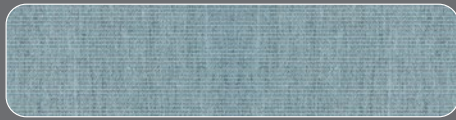

C78
MINERAL BLUE CHINE
260 gr/m²

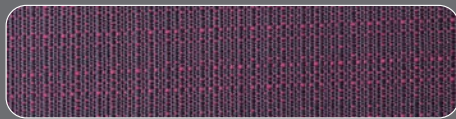

C59
IBIZA
270 gr/m²

50% Sunbrella Acrylic
50% Post Industrial Recycled Sunbrella Acrylic

CATEGORY H - Sailcloths / Sailing



C70
SAILOR SAILCLOTH
400 gr/m²



C69
SHADOW
SAILCLOTH
400 gr/m²

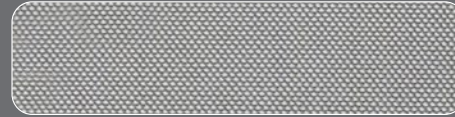

C60
SEAGULL GREY
SAILING
580 gr/m²

CATEGORY F - Stripes



C56
CAROUSEL
400 gr/m²



C57
DOLCE MANGO
260 gr/m²

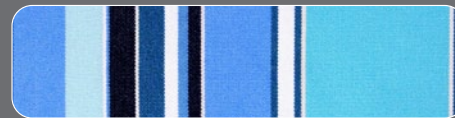

C58
DOLCE OASIS
260 gr/m²

AGORA® WATERPROOF CUSHIONS

100% Solution Dyed Acrylic
with a Waterproof Laminated Liner

Manufactured by Tuvatextil SL in Spain, specialists in solution dyed acrylic, Agora fabric has a waterproof laminated liner and has excellent anti-stain, oil repellent and mildew resistant capacities. The core of the Agora waterproof cushion is an open cell structure foam by Inoac®

We introduce the Agora cushion category in the Bondi and Ube ranges.



C94
ACQUA
300 gr/m2

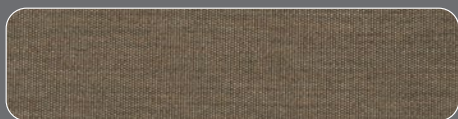

C95
COCO
300 gr/m2

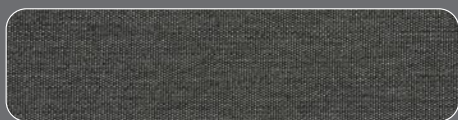

C96
GRAFITO
300 gr/m2



C97
CORAL DUST
300 gr/m2

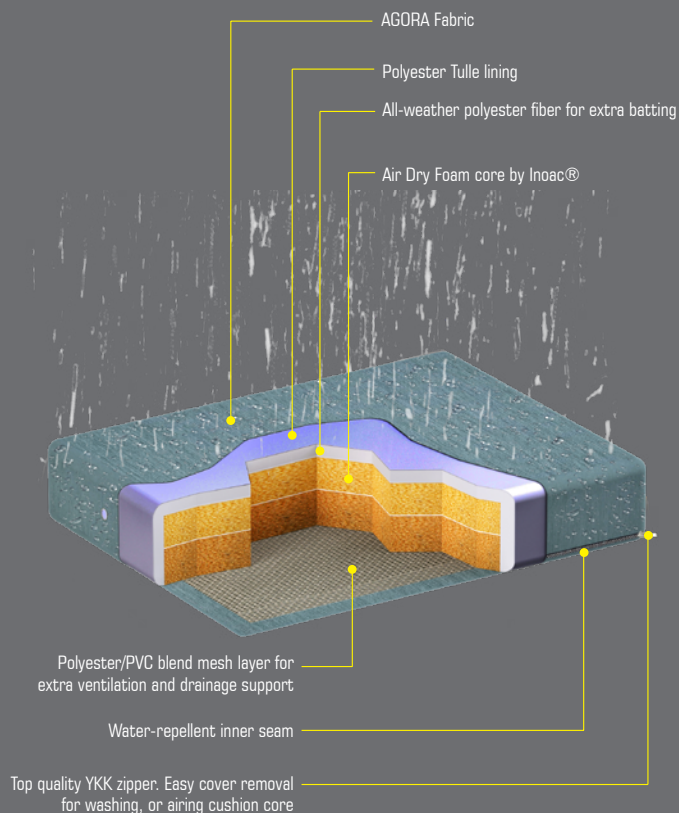

BATYLINE ELIOS NEW

Designed and manufactured in France
by Serge Ferrari

Application : IMO Rated Outdoor Cushions - NOT as a sling / mesh.

The new Batyline Elios range reflects a timeless, graphic look in covering your outdoor furniture to create a place of comfort.



FIRE RETARDANT
IMO 2010 FTP Code Part 8 compliant



C111
NIGHTSHADE
450 gr/m²

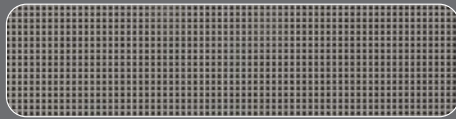

C112
COBBLE
450 gr/m²

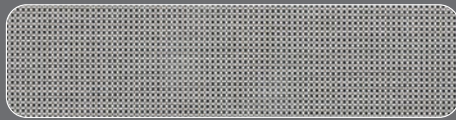

C113
OATMEAL
450 gr/m²



Batyline Elios

Uniquely soft. Elios' patented weave combines Batyline performance and durability with a textured yarn to offer a unique softness and high resistance.

Unfailing resistance. Batyline Elios has been subjected to the most stringent tests, guaranteeing its high-performance design. It stands up to exceptional abrasion, UV rays and moulds.

Real ease of cleaning. Batyline Elios is very easy to clean with everyday household products, allowing you to enjoy your outside furniture with peace of mind in all seasons.

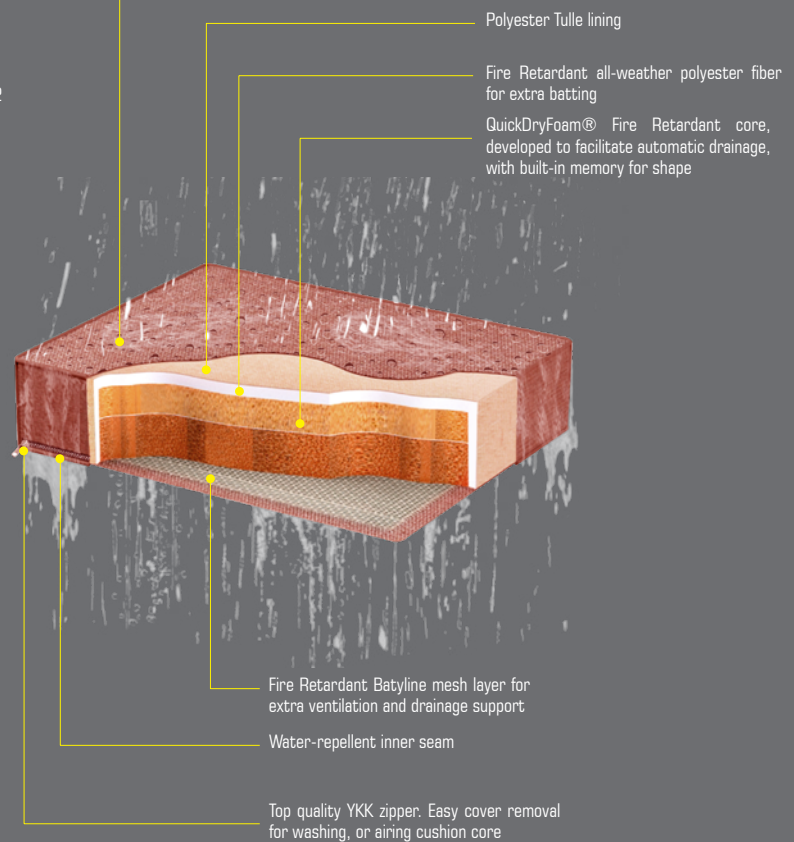

OLEFIN

Made in Indonesia by Ateja®
Application : chair pads / throw pillows



C108
MOONROCK
230 gr/m2

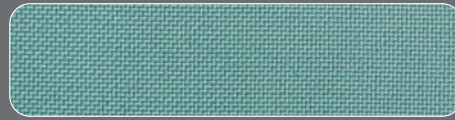

C72
MARINE
290 gr/m2



C107
PRESTIGE
230 gr/m2



C91
MIDNIGHT BLUE
230 gr/m2

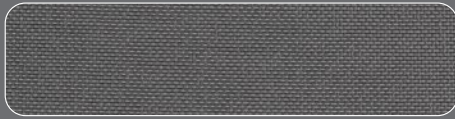

C46
STONE
290 gr/m2



C92
DEEP SEA
230 gr/m2



C71
CREME
290 gr/m2

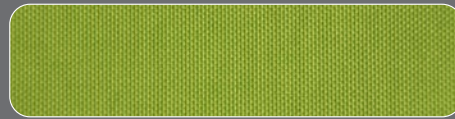

C87
PEAR
230 gr/m2



C41
TAUPE
290 gr/m2



C86
OLIVE
230 gr/m2



C47
SAND
290 gr/m2



C106
YELLOW
290 gr/m2



C45
WHITE
290 gr/m2



C90
TANGERINE
230 gr/m2



C81
BLACK
290 gr/m2



C88
MARSALA
230 gr/m2

*note that this is not available for standard upholstery cushions. Seat pads and pillows only



SCAN TO DOWNLOAD



NEW 2023



FAST



WORLD OF MAMAGREEN



MAINTENANCE | CARE |
WARRANTY



TERMS & CONDITIONS



✉ info@mamagreen.com

🌐 www.mamagreen.com

📷 [mamagreen_furniture](https://www.instagram.com/mamagreen_furniture)

📘 [mamagreenfurniture](https://www.facebook.com/mamagreenfurniture)

📌 [mamagreen_official](https://www.pinterest.com/mamagreen_official)

📄 [company/mamagreen](https://www.linkedin.com/company/mamagreen)